

## Product Change Notification

CHANGE NOTIFICATION	CHANGE TITLE	PRODUCT FAMILY	DATE OF PUBLICATION	PRODUCT PART NUMBER
BSKG	TM800 front foil design and housing dimensions changed	Control Panels	February 17, 2022	Housing overview attached
TYPE OF CHANGE	CLASSIFICATION OF CHANGE <sup>1)</sup>	PRODUCT CATEGORY		DEPARTMENT / LOCATION
Mechanical, Foil printing	B	TM800		BU-H

<sup>1)</sup> A: Stop of production or design change with influence of approval/ **Einstellung der Produktion oder Konstruktionsänderung mit neuer Zulassung benötigt.**

B: Small change in design without influence of approval/ **Geringfügige Änderung des Designs ohne Einfluss der Zulassung**

C: No influence of product/ **Keine Auswirkung auf das Produkt**

### DESCRIPTION OF CHANGE:

Front panel design changed.

The housing material were changed to aluminum.

### KEY CHARACTERISTICS OF CHANGE:

Front panel design changed.

The housing material has been changed to aluminum, this has an impact on the outer dimensions of the housing.

Preference types housing/Wallbox\*:

Type* (Name-W-H-D)	UPB bezel frame dimension	UPE Tile frame dimension	Housing outer dimensions** (WxH) mm	Wall cutout dimensions	Material
UPAF-303-303-120mm	W+30mm x H+30mm	W-6mm x H-6mm	<b>303x303</b>	W+3mm x H+3mm	B22000176
UPAF-303-453-120mm	W+30mm x H+30mm	W-6mm x H-6mm	<b>303x453</b>	W+3mm x H+3mm	B22000177
UPAF-453-453-120mm	W+30mm x H+30mm	W-6mm x H-6mm	<b>453x453</b>	W+3mm x H+3mm	B22000172
UPAF-453-453-150mm	W+30mm x H+30mm	W-6mm x H-6mm	<b>453x453</b>	W+3mm x H+3mm	B22000178
UPAF-453-603-120mm	W+30mm x H+30mm	W-6mm x H-6mm	<b>453x603</b>	W+3mm x H+3mm	B22000173
UPAF-453-603-150mm	W+30mm x H+30mm	W-6mm x H-6mm	<b>453x603</b>	W+3mm x H+3mm	B22000179
UPAF-603-603-120mm	W+30mm x H+30mm	W-6mm x H-6mm	<b>603x603</b>	W+3mm x H+3mm	B22000174
UPAF-603-603-150mm	W+30mm x H+30mm	W-6mm x H-6mm	<b>603x603</b>	W+3mm x H+3mm	B22000181
UPAF-603-753-120mm	W+30mm x H+30mm	W-6mm x H-6mm	<b>603x753</b>	W+3mm x H+3mm	B22000175
UPAF-603-753-150mm	W+30mm x H+30mm	W-6mm x H-6mm	<b>603x753</b>	W+3mm x H+3mm	B22000182
Surface Mounting	Two different depth are available 60mm and 120mm. Requires consulting				

\*\* Additional 10 mm circumferential housing flange.

\*Other housing dimensions available on request at extra cost.

**BENDER Group**

**FORECAST KEY MILESTONES:**

Time Schedule	Current Product	New Product
Series	TM800	TM800
Product name	TM800	TM800
Product number	N.A	N.A
First Shipment		26.08.2020 See PM-Note 2020-006_EN
Last Order		30.11.2023
Last Shipment		See PDN_2021-005_EN/DE
Samples available		N.A
Charge Indication	N.A	N.A

**ADDITIONAL INFORMATION:**

	Current Product	New Product
Documentation	TM800_D00165_00_M_XXEN/06.2015	TM800_D00165_00_M_XXEN/06.2015 supplemented with - PCN TM800
Pictures		
Dimensions		See table under Key Characteristics of change
Certifications	No changes	No changes

Issued by	J. Sonntag	Date	February 17, 2022
-----------	------------	------	-------------------



# TM800

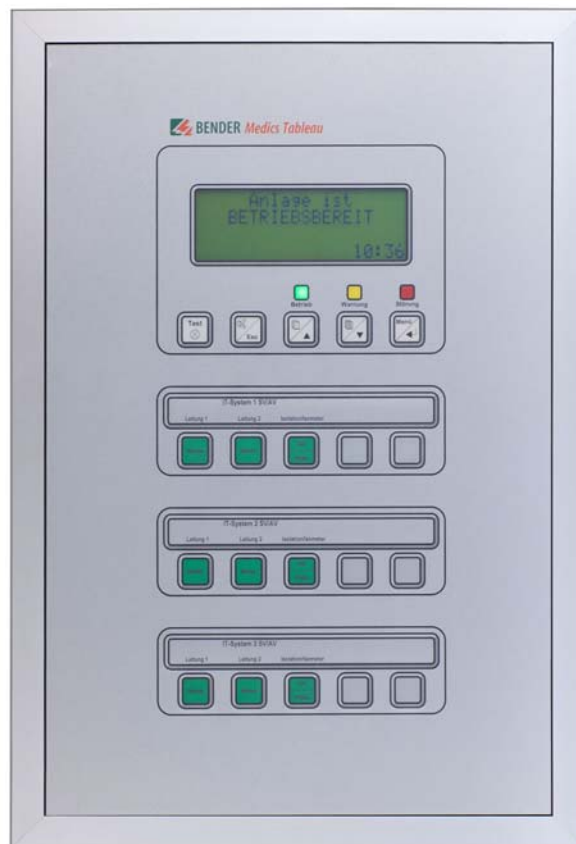

**Alarm indicator and operator panel**  
**Software version: 4.0x**



**Bender GmbH & Co. KG**

P.O. Box 1161 • 35301 Gruenberg • Germany  
Londorfer Straße 65 • 35305 Gruenberg • Germany  
Tel.: +49 6401 807-0 • Fax: +49 6401 807-259  
E-mail: [info@bender.de](mailto:info@bender.de) • [www.bender.de](http://www.bender.de)

Photos: Bender archives.

© Bender GmbH & Co. KG  
All rights reserved.  
Reprinting only with permission  
of the publisher.  
Subject to change!

# Table of Contents

<b>1. How to get the most out of this manual .....</b>	<b>7</b>
1.1 How to use this manual .....	7
1.2 Explanation of symbols and notes .....	7
<b>2. Safety instructions .....</b>	<b>9</b>
2.1 Intended use .....	9
2.2 Qualified personnel .....	9
2.3 General safety instructions .....	9
2.4 Delivery conditions, warranty and liability .....	10
<b>3. System description .....</b>	<b>11</b>
3.1 MEDICS® .....	11
3.2 TM800 features .....	12
3.3 Functionality of the TM800 .....	13
3.3.1 LC display .....	13
3.3.2 Programmable messages .....	14
3.3.3 History memory .....	14
3.3.4 Interfaces .....	14
3.3.4.1 BMS bus .....	14
3.3.4.2 USB interface .....	15
3.3.5 Programming and reading the TM800 .....	15
3.3.5.1 Connection of the personal computer .....	15
3.3.5.2 Optional software .....	15
3.3.6 Firmware versions .....	15
3.4 Mechanical design .....	16
3.4.1 Module overview .....	16
3.4.2 BM800 and BM400 modules .....	16
3.4.2.1 BM800 .....	16
3.4.2.2 BM400 .....	16
3.4.3 Operating and display modules .....	16
3.4.4 Inputs and outputs .....	17
3.4.4.1 Digital output 1 .....	17
3.4.4.2 I/O modules .....	17
3.4.5 Individual internal components .....	18

<b>4. Installation and connection</b> .....	<b>19</b>
4.1 Installation .....	19
4.1.1 Overview of enclosure variants .....	19
4.1.2 Unpacking .....	20
4.1.3 Installing the flush-mounting type enclosure with bezel frame (UPB) .....	21
4.1.4 Installing the flush-mounting enclosure with mounting frame (UPE) .....	22
4.1.5 Mounting the front plate .....	24
4.1.5.1 Flush-mounting type enclosure with bezel frame (UPB) .....	24
4.1.5.2 Flush-mounting type enclosure with mounting frame (UPE) .....	25
4.1.6 Installation of the surface-mounting enclosure (AP) .....	26
4.1.7 Opening the front plate .....	27
4.2 Connection .....	28
4.2.1 Connection details .....	28
4.2.2 Modules and connections of the TM800 (connection example) .....	29
4.2.3 BMS-bus connection .....	31
4.2.3.1 Terminating resistor .....	31
4.3 Examples for connection and address assignment .....	32
4.3.1 Address settings and their meaning .....	35
<b>5. Commissioning and testing</b> .....	<b>37</b>
5.1 Tests before switching on .....	38
5.2 Tests after switching on .....	39
5.3 Make settings (parameterisation) .....	39
5.3.1 Settings at the TM800 .....	40
5.3.2 Settings using the TMK-SET software .....	41
5.3.3 Tests after parameter setting .....	42
5.4 Periodic verification and service .....	43
5.4.1 Periodic verification .....	43
5.4.2 Service .....	44
5.4.3 Maintenance .....	44
<b>6. Troubleshooting</b> .....	<b>45</b>
6.1 Error messages .....	45
6.2 Malfunctions .....	46
6.3 Replace flash memory .....	48
<b>7. Operation</b> .....	<b>49</b>
7.1 Operator control and display elements .....	49
7.2 Quick reference guide .....	50

7.2.1	Display under normal operating condition .....	50
7.2.2	Display during fault condition .....	51
7.2.3	Test function .....	52
<b>8.</b>	<b>Menu mode: Operation and setting .....</b>	<b>55</b>
8.1	Switching on and calling the main menu .....	55
8.2	Menu overview diagram .....	56
8.3	Main menu functions .....	57
8.4	The main menu .....	57
8.4.1	Exit .....	57
8.4.2	Menu2: Values .....	57
8.4.3	Menu 3: History .....	57
8.4.4	Menu 4: Settings .....	59
8.4.4.1	Exit .....	59
8.4.4.2	Settings menu 2: Alarm addresses .....	59
8.4.4.3	Settings menu 3: Test addresses .....	60
8.4.4.4	Settings menu 4: Measurement addresses .....	61
8.4.4.5	Settings menu 5: Digital inputs .....	61
8.4.4.6	Settings menu 6: Buzzer (and LED) .....	63
8.4.4.7	Settings menu 7: Common reset .....	63
8.4.4.8	Settings menu 8: Clock .....	63
8.4.4.9	Settings menu 9: Language .....	64
8.4.4.10	Settings menu 10: Interface .....	65
8.4.4.11	Settings menu 11: Relays .....	65
8.4.4.12	Settings menu 12: Password .....	66
8.4.4.13	Settings menu 13: Service menu .....	66
8.4.5	Menu 5: Control .....	67
8.4.5.1	Exit .....	67
8.4.5.2	Control menu 2: Reset (AlarmClear) .....	67
8.4.5.3	Control menu 3: EDS Start/Stop .....	67
8.4.5.4	Control menu 4: Test communication .....	68
8.4.5.5	Control menu Reset mode .....	68
8.4.6	Menu 6: External devices .....	68
8.4.7	Menu 7: Info .....	70
8.5	Overview of setting options .....	71
<b>9.</b>	<b>Technical data .....</b>	<b>73</b>
9.1	Technical data BM800/BM400 modules .....	73
9.1.1	Standards, approvals and certifications .....	74
9.2	Dimensions .....	75

9.2.1	Surface-mounting enclosure, aluminium, silver matt anodised .....	76
9.3	Ordering details .....	76
<b>10.</b>	<b>Internal components and modules .....</b>	<b>77</b>
10.1	BM800 and BM400 module .....	77
10.1.1	BM800 and BM400 dimensions .....	77
10.2	Operating and display module BI800S .....	78
10.2.1	BI800S dimensions .....	78
10.2.2	Wiring diagram BI800S .....	78
10.2.3	Technical data BI800S .....	78
10.2.4	Ordering information BI800S .....	79
10.3	Operating and display module BI71S .....	80
10.3.1	BI71S dimensions .....	80
10.3.2	Wiring diagram BI71S .....	80
10.3.3	Technical data BI71S .....	81
10.3.4	Ordering information BI71S .....	81
10.4	Operating and display module BI72S .....	82
10.4.1	BI72S dimensions .....	82
10.4.2	Wiring diagram BI72S .....	82
10.4.3	Technical data BI72S .....	83
10.4.4	Ordering information BI72S .....	83
10.5	I/O module BMI8/8 .....	84
10.5.1	BMI8/8 dimensions .....	84
10.5.2	Wiring diagram BMI8/8 .....	84
10.5.3	Technical data BMI8/8 .....	85
10.6	I/O module BMI8/4 and BMI0/4 .....	86
10.6.1	BMI8/4 and BMI0/4 dimensions .....	86
10.6.2	Wiring diagram BMI8/4 and BMI0/4 .....	86
10.6.3	Technical data BMI8/4 and BMI0/4 .....	87
<b>INDEX</b> .....		<b>89</b>



# 1. How to get the most out of this manual

## 1.1 How to use this manual

This operating manual describes the TM800 alarm indicator and operator panel with the software version specified on the title page. The functions and processes described may vary from those featured in other versions. This manual is intended for qualified personnel working in electrical engineering and electronics and in particular for those designing, installing and operating electrical equipment in medical locations.

Chapter "Operation" on page 49 can also be used as a quick reference guide by medical personnel.

Before using the devices, please read this operating manual, the supplement entitled "Important safety instructions for Bender Products" and the instruction leaflets supplied with the individual system components. Keep this document in an easily accessible location near to the devices.

Should you have any further questions, please contact our Technical Sales department. We are also happy to provide on-site service. Contact our Service Department for more information.

Although great care has been taken in the drafting of this operating manual, it may nevertheless contain errors and mistakes. Bender cannot accept any liability for injury to persons or damage to property resulting from errors or mistakes in this manual.

## 1.2 Explanation of symbols and notes

The following terms and symbols are used to denote hazards and instructions in Bender documentation:



*The signal word indicates that there is a **high** risk of danger that **will** result in **death** or **serious injury** if not avoided*



*This signal word indicates a **medium** risk of danger that **can** lead to **death** or **serious injury**, if not avoided.*



*This signal word indicates a **low level** risk that can result in minor or **moderate injury** or **damage to property**, if not avoided.*



*This symbol denotes information intended to assist the user in making optimum use of the product.*



## 2. Safety instructions

### 2.1 Intended use

In terms of human/machine interface, alarm indicator and operator panels play a crucial role. Their task is to take system information and transform it into clear instructions, particularly in the event of critical operating situations. The flexible TM800 alarm indicator and operator panels provide solutions that meet the requirements of modern medical facilities as well as industrial and functional buildings. They are used for

- the display and visualisation of operating status, warning and alarm messages
- central operation and parameterisation of BMS bus devices (BMS = Bender Measuring Device Interface)
- the output of visual and audible warning messages
- the display of measured values from Bender monitoring systems with BMS interface, such as MEDICS®, RCMS or EDS

In addition, they are used for the display, control and operation of

- operating theatre tables
- equipment for supplying medical gases
- battery-supported central power supply systems (BSV systems)
- air conditioning and ventilation systems
- room lighting
- communication equipment
- and third-party systems.

All technical devices installed in one alarm indicator and operator panel constitute a technology centre in the relevant room.

Please heed the limits of the area of application indicated in the technical specifications. Use which deviates from or is beyond the scope of these technical specifications is considered non-compliant.

**Use for the intended purpose also includes:**

- Device-specific settings compliant with local equipment and operating conditions.
- The observation of all information in the operating manual.
- Compliance with test intervals.

### 2.2 Qualified personnel

Only appropriately qualified personnel may work with the Bender devices. Personnel who are familiar with the installation, commissioning and operation of the equipment and have undergone appropriate training are considered qualified. Personnel must have read this manual and understood all instructions relating to safety.

### 2.3 General safety instructions

Bender devices are designed and built in accordance with the state of the art and accepted rules in respect of technical safety. However, the use of such devices may introduce risks to the life and limb of the user or third parties and/or result in damage to Bender devices or other property. Only use

Bender devices:

- As intended
- In perfect working order
- In compliance with the accident prevention regulations and guidelines applicable at the location of use
- Eliminate all faults immediately which may endanger safety.
- Do not make any unauthorised changes and only use replacement parts and optional accessories purchased from or recommended by the manufacturer of the devices. Failure to observe this requirement can result in fire, electric shock and injury.
- Reference signs must always be clearly legible. Replace damaged or illegible signs immediately.
- Make sure that the dimensions of the BSV (battery-supported safety power supply), the generator set and the whole wiring are adequate. The applicable national and international standards must be observed here. Only in this way selective operation of safety devices can be achieved and a high degree of safety in case of overload and short circuit can be ensured.

## 2.4 Delivery conditions, warranty and liability

The conditions of sale and delivery set out by Bender apply. Conditions of sale and delivery can be obtained from Bender in printed or electronic format.

## 3. System description

### 3.1 MEDICS®

The TM800 alarm indicator and operator panel is an integral component of the MEDICS® system. MEDICS® is an intelligent system that guarantees safe power supply in medical locations.

Example of a section of a hospital with the MEDICS® system

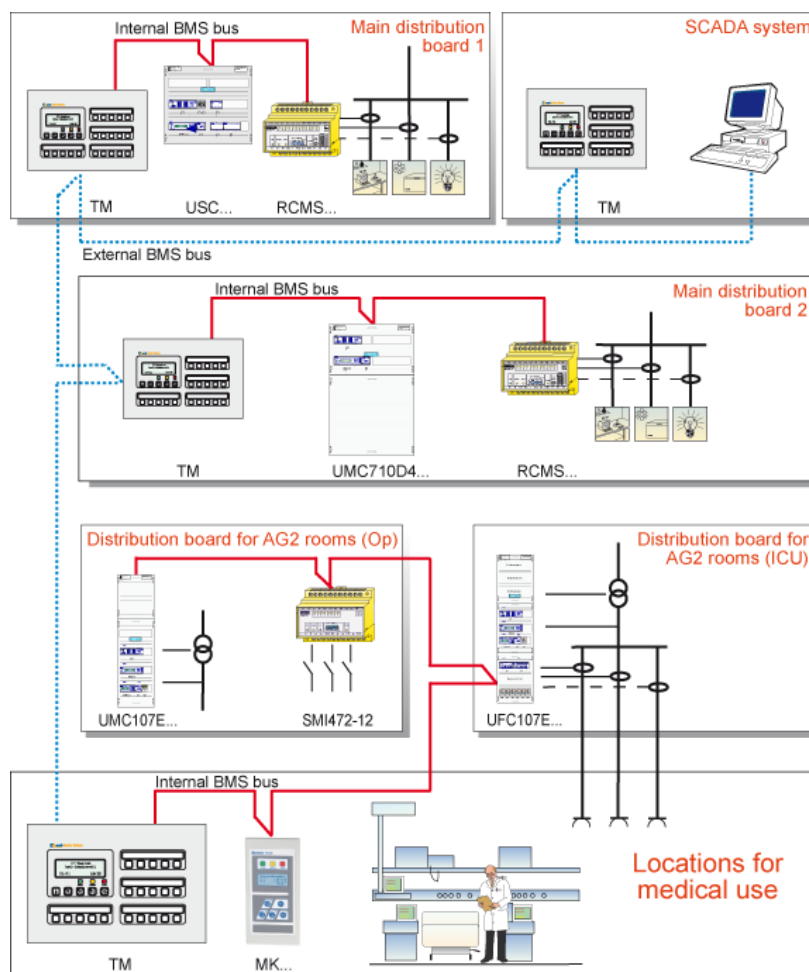

#### Legend to the illustration above

- MK... Alarm indicator and test combination
- RCMS... Residual current monitoring system for TN-S systems
- SMI472 Signal converter for third-party technical equipment (e.g. med. gases, BSV (battery-supported systems))
- TM... Alarm indicator and operator panel
- UFC107E... Changeover and monitoring module for IT systems with EDS insulation fault location system
- UMC107E... Changeover and monitoring module for IT systems
- UMC710D... Changeover module for main distribution boards
- USC710D... Control module for changeover modules (preferably in main distribution boards)
- SCADA system (Supervisory Control and Data Acquisition)

**MEDICS® includes:**

- Single and three-phase monitoring modules. MEDICS® system modules are, for example: UMC..., USC..., UFC... and/or EDS... insulation fault location systems
- Display and operating units such as TM... alarm indicator and operator panels or MK... alarm indicator and test combinations
- Communication between these components via the BMS bus (two-wire connection).
- The connection of third-party technical systems by means of protocol converters (gateways) or via digital inputs and relay outputs.

The real strength of MEDICS® is to be found in communication between all involved components and the resulting information provided to the user. The functionality of the equipment is continuously monitored. Operating states, irregularities, faults and equipment failures are displayed. This means high operational reliability of the installation for the user.

### 3.2 TM800 features

On its backlit LC display, the TM800 displays messages from all BMS-bus devices and digital inputs assigned via alarm addresses. As well as being used as a standalone indicator, the TM800 also supports parallel indication in different rooms. In the event of an alarm message, the yellow LED "WARNING" or the red LED "ALARM" lights up and the message appears on the LC display in plain text format. At the same time there is an audible signal (can be acknowledged/muted). If a second message is received whilst the first is still pending, the audible signal will sound again and the messages will appear alternately on the LC display. The address of the device triggering the alarm can also be called up. The audible signal sounds again once a configurable period of time has elapsed (repetition can be deactivated). Illuminated pushbuttons can be programmed to signal alarms and operating states or for programming operating information. Operator actions or messages can be output via digital outputs.

Internal device parameters (alarm addresses, test addresses...) and the parameter setting of EDS- and RCMS systems can be accessed via the menu system. TM800 can be also be used as a master device in installations with a number of IT and EDS systems.

The test button can be used to check the function of the associated devices such as insulation monitoring devices, LIM (Line Isolation Monitors) or GFCI (Ground Fault Circuit interrupters). The message is output only on the TM800 on which the test button "TEST" was pressed. The test and its individual evaluations are carried out sequentially. Finally, a message appears indicating either a successful test or a fault.

**TM800 features:**

- Display, control and operation of Bender monitoring systems and third-party systems
- Backlit clear LC text display (4 x 20 characters, 8 mm)
- Additional text with specific information for technical and medical personnel can be displayed
- LEDs in traffic light colours: 3 LEDs for optical differentiation of messages
- Predetermined standard texts in 21 languages for Bender MEDICS® systems
- 1000 freely programmable message texts (with TMK-SET PC software)
- Audible alarm (can be acknowledged or muted)
- Easy parameterisation:
  - with a personal computer (USB interface, BMS bus): TM800, MK800, EDS46x, EDS47x, EDS49x, RCMS460, RCMS470, RCMS490
  - via menu: TM800 basic parameters

- History memory with real-time clock to store 1000 warning and alarm messages
- Variable operator and display modules with a freely programmable function
- Easy integration with third-party systems, because operating theatre table controls, medical gases, intercom systems are behind a closed foil surface
- Control of third-party systems by flexible I/O modules with galvanic separation
- Alarm LED at each input/output for fast diagnosis
- Functions can be easily extended by adding I/O modules
- Clearly defined structure thanks to an external and internal bus
- Non-reflecting, multi-coloured foil surface
- Optionally available with an antibacterial foil surface

### 3.3 Functionality of the TM800

#### 3.3.1 LC display

The backlit features four lines of 20 characters. It assists medical and technical personnel during the decision-making process with information that is always clear and unambiguous. Every alarm message comprises three lines which appear spontaneously and three additional lines which can be displayed at the touch of a button. The fourth line contains status information (the number of messages, test procedures, menu information).

Below the text display, three LEDs are arranged. They indicate: normal operation (green), warning (yellow) or alarm messages (red).

Five buttons are available to acknowledge or to mute alarm and warning messages, for testing the assigned devices and for the menu system.

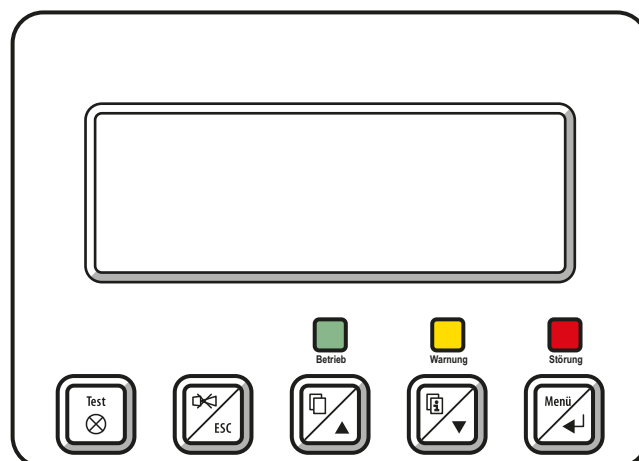

### 3.3.2 Programmable messages

Standard message texts can be activated by enabling alarm addresses. These texts are available in 21 national languages. Alarm addresses can be enabled via the device menu system (without personal computer). Individual message texts, each comprising 6 lines à 20 characters can be programmed with the TMK-SET software. Up to three outputs can be assigned to each alarm. An LED (yellow or red) and an audible signal can be assigned to each message. For this purpose, the PC is connected to the USB interface or BMS bus (RS-485). In addition to the buzzer, a relay can be activated that enables, for example, an alarm horn sound in a loud environment.

### 3.3.3 History memory

Warnings and alarms with date and time stamp are automatically written to the history memory. 1000 text messages can be stored. Each subsequent message overwrites the oldest message in the history memory (message 1001 will overwrite message 1 etc.). The history memory can be read out via the operating menu or the TMK-history PC software.

### 3.3.4 Interfaces

Alarm indicator and operator panels feature different interfaces, for communication with third-party systems and/or MEDICS® components:

- Internal BMS bus
- External BMS bus
- USB interface

#### 3.3.4.1 BMS bus

The BMS bus system (BMS=Bender Measuring Device Interface) guarantees high operational reliability:

- Based on the tried and tested industrial standard RS-485
- A self-contained system - not influenced by third-party systems
- Redundant master function and data transmission (internal and external bus)
- Mutual device monitoring
- Open, thanks to defined interfaces, e.g. OPC server

#### Internal BMS bus

The internal BMS bus is used for communication with BMS bus devices,

- e.g. modules like UMC..., UMA..., UFA..., UFC..., LFC..., ATICS®
- or devices like RCMS..., EDS..., SMI..., SMO..., MK800..., TM800

Up to 30 devices can be connected to each internal bus line (in combination with the DI-1PSM repeater up to 150). One address is assigned to each bus device. Address 1 is assigned to the TM800 alarm indicator and operator panel which represents the master on the internal bus.

If the external BMS bus is switched off, addresses 2...150 (slave) can be selected on the internal bus.



### External BMS bus

The external BMS bus enables communication with other TM800 alarm indicator and operator panels, SMI472-12 or BMS-OPC servers. The master function is cyclically passed to the subsequent master on the external bus. The TM800, with address 1, however, takes over some special tasks:

- As a "master clock", it synchronises the time of all devices on the internal BMS bus
- It ensures that the required supply voltage is available on the external BMS bus.

Messages can be displayed on any TM800 alarm indicator and operator panel via the external BMS bus. The PC software TMK-SET is used to assign the messages accordingly.

A personal computer is recommended to be connected via the external BMS bus to the TM800 alarm indicator and operator panel. Any information of the TM800 panels connected to the external BMS bus can be displayed and set at a central point. If the personal computer does not feature an RS-485 interface, an RS-232/RS-485 converter DI-2 or a USB/RS-485 converter DI-2USB will be required.

#### 3.3.4.2 USB interface

A personal computer can also be connected to the TM800 via the USB interface using a standard-USB device cable (type A/type B). To access the USB interface plug, open the front plate.

Only the connected TM800 can be read out and set via the USB interface.

### 3.3.5 Programming and reading the TM800

#### 3.3.5.1 Connection of the personal computer

Connect the TM800 to a personal computer:

- directly via the USB interface or
- via an RS-232/RS-485 converter DI-2 or a USB/RS-485 converter DI-2USB to the internal or external BMS bus.

#### 3.3.5.2 Optional software

- You can use the PC software TMK-SET to read, display and change the TM800 settings.
- You can use the PC software TMK-History to read the history memory of the TM800 (download from <http://www.bender-de.com>).
- BMS-OPC server

#### 3.3.6 Firmware versions

The TM800 is controlled by an internal software (firmware).



*All devices sharing one external BMS bus must be equipped with compatible software versions. The following software versions are required:*

<i>TM</i>	<i>V 4.0 or higher</i>
<i>SMI472</i>	<i>V 2.03 or higher</i>

*All devices must be set to the same baud rate.*

## 3.4 Mechanical design

### 3.4.1 Module overview

The TM800 alarm indicator and operator panels are based on a modular design. The appropriate combination of modules will be made by Bender so that the user is not unnecessarily burdened with planning details. This chapter provides a summary of the applicable modules:

- BM800 Module for TM800 alarm indicator and operator panel
- BM400 module like BM800, but without an LC display and control buttons
- BI... operating and display modules each with five illuminated pushbuttons
- BMI... I/O modules (digital inputs, relay outputs, open collector outputs)
- Individual components (remote operating table control, intercom systems...)

### 3.4.2 BM800 and BM400 modules

#### 3.4.2.1 BM800

Module for a TM800 alarm indicator and operator panel with LC display. BM800 features:

- LC display (without a front foil, because this is included already in the front plate of TM800)
- one operating LED, warning and alarm LED each as common alarm LEDs
- 5 control buttons
- Interfaces 2 x RS-485, 1 x USB, 2 x I<sup>2</sup>C
- Buzzer

#### 3.4.2.2 BM400

BM400 is a module similar to BM800, but without LC display and control buttons. These operating and display modules together with digital I/O modules can be configured to form indicator and operator panels.

### 3.4.3 Operating and display modules

The operating and display modules consist of 5 elements. Depending on the panel type, different numbers of modules are available (also see "Internal components and modules" on page 77ff).

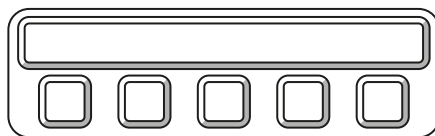

Type	Characteristics
BI800S	Operating and display elements to expand the BM800/BM400 modules. 16 BI800S modules can be controlled via I <sup>2</sup> C bus. One individual function (switch, button, LED etc.) can be assigned to each element.
BI71S	Operating and display elements without an I <sup>2</sup> C bus: 5 illuminated pushbuttons, 5 potential free changeover contacts, max. AC 250 V/8 A.
BI72S	Operating and display elements without an I <sup>2</sup> C bus: 5 illuminated pushbuttons, 5 potential free changeover contacts, max. AC 24 V/0.9 A

### 3.4.4 Inputs and outputs

Digital inputs and outputs as well as relay outputs are available for the control and indication of different technical equipment. The I/O modules are controlled via I<sup>2</sup>C bus.

The digital inputs are designed for a voltage of AC/DC 0...30 V (HIGH=10...30 V; LOW=0...2 V). In practice, these digital inputs are controlled via an internal or external voltage and potential-free contacts (N/C or N/O operation, selectable). The voltage required for these inputs can be supplied by the built-in power supply unit. The behaviour of the alarm contact at the digital input (N/O contact or N/C contact) can be assigned via this PC software. That means that the hardware of the alarm indicator and operator panel does not need to be changed in case of subsequent changes of the contact behaviour.

Digital inputs or outputs (potential free relay contacts or open collector outputs) are controlled by warning or alarm messages, via operating and display modules or the digital inputs. A message, a digital input or an illuminated pushbutton can be assigned to a relay output via the PC software TMK-SET.

The I/O modules are snapped on a DIN rail in the flush-mounting box separately from the display and the pushbutton panels. So the system can easily be expanded. Each input and output provides an alarm LED so that the status is visible at a glance for the technical staff.

#### 3.4.4.1 Digital output 1

When an I/O module BMI8/8, BMI8/4 or BMI0/4 is built in, the first output can be programmed individually. It can be used for system functions (see "Settings menu 11: Relays" on page 65). The output switches when:

- an internal TM800 device error is recognised
- the test button is pressed (relay will be activated for approx. 1.5 s)
- a device failure is recognised on the BMS bus,
- any warning or alarm message occurs (common alarm)
- the buzzer sounds (relay is activated when buzzer sounding)

The output can also be programmed via TMK-SET like all other outputs.



*TM800 alarm indicator and operator panels offer safe separation according to IEC 60664 between the relay contacts and the electronics, interface outputs, digital inputs and among each other.*

#### 3.4.4.2 I/O modules

Type	Characteristics
BMI8/8	8 digital inputs, 8 open collector outputs The open collector outputs are capable of driving a load of up to 15 W at an operating voltage of 24 V. They feature flyback diodes for the connection of relays.

Type	Characteristics
BMI8/4	8 digital inputs, 4 relay outputs The digital outputs correspond to those of the BI8/8 module. The potential-free output relays feature one changeover contact each AC 250 V, 5 A (AC1).
BMI0/4	Expansion for BMI8/4 by 4 relay outputs. The module BMI0/4 can only be used in combination with the BMI8/4 module. The potential-free output relays feature one changeover contact each AC 250 V, 5 A (AC1).

**3.4.5 Individual internal components**

In addition to the operating functions activated via operating and display modules, often complete operating units from a third-party manufacturer are integrated into the alarm indicator and operator panel. Typical examples are operating table controls or intercom systems. These modules are integrated in the alarm indicator and operator panels by Bender so that an aesthetically attractive functional solution is available, documented by the official release of the manufacturer. The required connections are made in accordance with the specifications of the respective manufacturer.

**Typical examples of third-party systems used in medical locations**

Med. gases	Intercom systems	Operating theatre light	Operating theatre table
Dräger	Digicom-Scanvest	ALM	Maquet
	Gehrke	Berchtold	Trumpf
	Schneider	Dräger	
	Stentofon	Haraeus	
	Telecom Behnke		

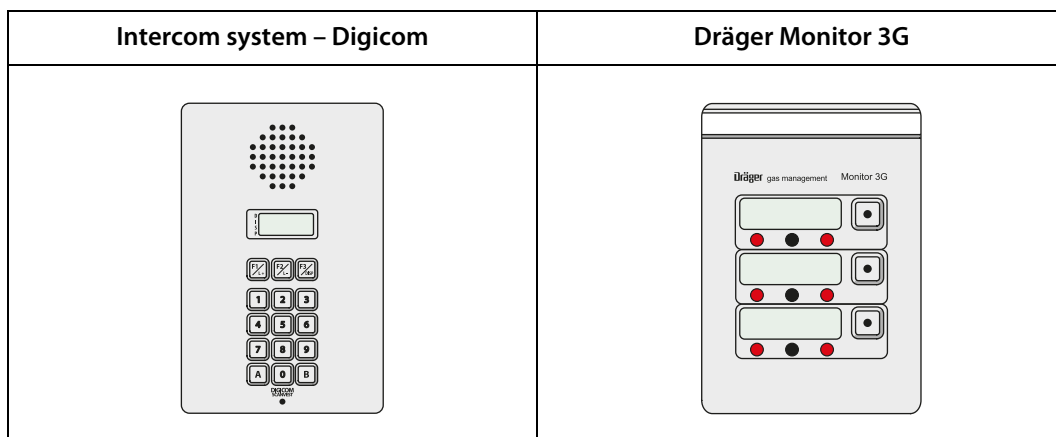

## 4. Installation and connection

### 4.1 Installation

#### 4.1.1 Overview of enclosure variants

The design of the alarm indicator and operator panels is based on the individual customer requirements in terms of interior design and the architect's and constructor's needs. In addition to the basic versions also room-high stainless-steel alarm indicator and operator panels or other versions are available.

The foil surface is completely closed, i.e. there are no screws needed for fixing the front plate. The panel is easy to clean so that a high standard of hygiene is guaranteed. For additional protection, the front panel surface can also be delivered with antibacterial surface.

#### Flush-mounting type enclosure with bezel frame (UPB)



A gap of up to 12 mm between the flush-mounted enclosure and the wall can be concealed by a bezel frame made of anodised aluminium. This version is recommended to be used for wallpapered walls or walls with non-standard tiles, for example.

#### Flush-mounting type enclosure with mounting frame (UPE)



The mounting frame permits accurate and close wall mounting. The mounting frame is made of anodised aluminium. The mounting frame version is preferably used where the enclosure is required to fit exactly the dimension of the tiles.

### Surface-mounting enclosure (AP)



The anodised surface-mounting enclosure is suitable for both pure surface-mounting and for partially recessed mounting. The enclosures can be supplied with a depth of 90, 150 and 210 mm.

The support frame inside the flush-mounted or surface-mounted case is fitted with a long-term elastic seal in order to avoid the ingress of cleaning agents into the panel. Depending on the size, the front plate is connected to the flush mounting or surface mounting enclosure by two or more stable hinges. This guarantees easy installation of the alarm indicator and operator panel.

All necessary modules and display elements are permanently fixed to the front plate using threaded bolts or mounting frames. The front plate is connected with the mounting plate via a flexible spiral hose that is fixed on both sides with cable clips. The technical equipment and systems are connected to a terminal board that is fixed on a mounting plate. The power supply unit for the alarm indicator and operator panel is also located on this mounting plate. The mounting plate can easily be dismantled. That allows the flush-mounting or surface-mounting enclosure to be installed prior to the final assembly stage. Cable connections between the front plate and the terminal board also do not need to be disconnected.

With the exception of the mounting plate no other components are fixed to the baseplate of the flush-mounting/surface-mounting enclosure, allowing sufficient room for installation.

#### 4.1.2 Unpacking

Unpack all the parts supplied with the system. Do not use sharp-edged tools that may damage the content of the packaging.

Compare your order with our delivery note to check that you have received all products in full. The article numbers printed on the nameplates simplifies the identification of the devices.



*Check all parts supplied for any evidence of damage in transit. Devices damaged in transit must not be used. If a device is damaged, please contact Bender. Details of who to contact are indicated on the delivery document.*



*Before using devices that have been stored at low temperatures: Leave the devices to stand for 3 to 4 hours at room temperature before connecting the power supply. A change in temperature from cold to warm will result in condensation on all device components. Putting damp devices into operation risks damaging electrical components and there is a danger of electric shock on contact.*

### 4.1.3 Installing the flush-mounting type enclosure with bezel frame (UPB)

Note: Do not remove the plaster cover and the fixing brackets during the installation to protect the wall-mounting enclosure!

1. Before inserting the cables remove the knockouts. Guide the power supply cables into the enclosure.
2. Install the flush-mounting enclosure in a way that the enclosure (and thus the plaster cover) are approximately 2 mm below the finished surface of the wall.
3. After installing the enclosure securely, remove the plaster cover and the fixing brackets. Then install the bezel frame into the flush mounting enclosure.

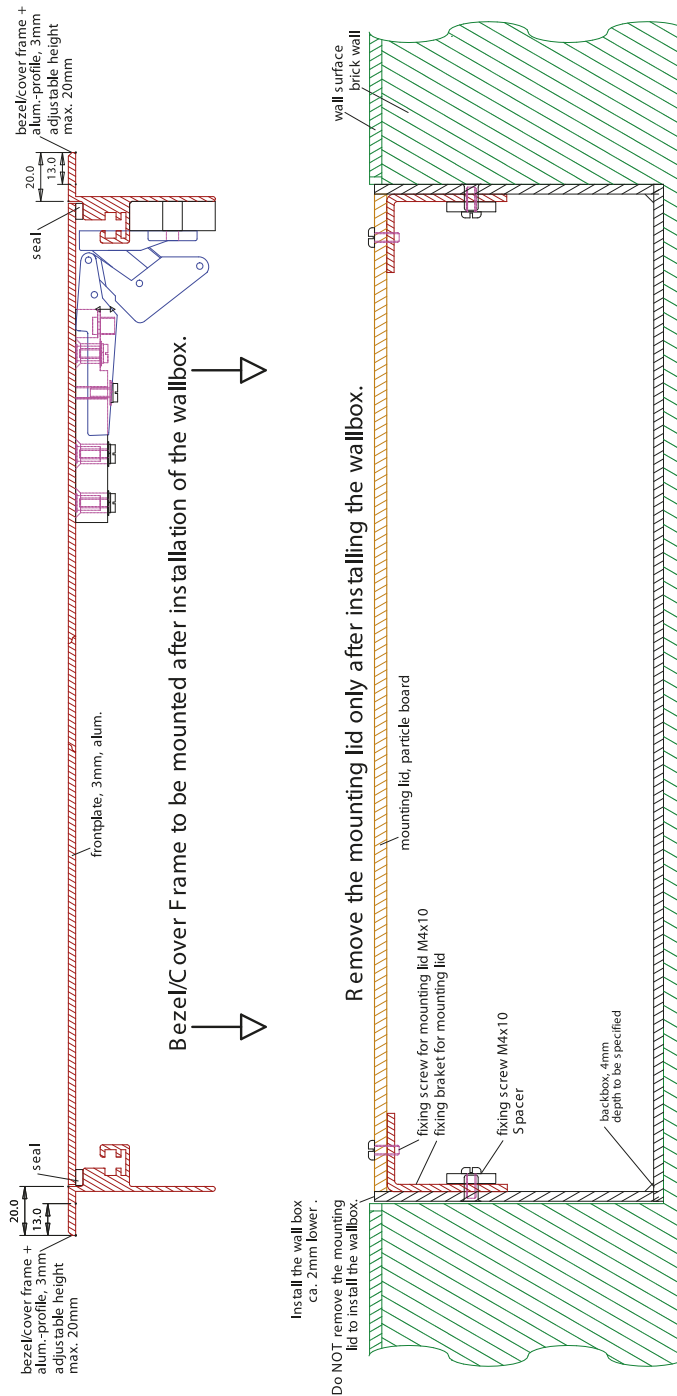

Drawing no.: 9800267

#### 4.1.4 Installing the flush-mounting enclosure with mounting frame (UPE)

The front plates are fitted into the wall-mounting enclosure and identified by a number identical to the number of the enclosure. The front plate number must be identical to the enclosure number!

Note: Do not remove the plaster cover during the installation to protect the wall-mounting enclosure!

1. Before inserting the cables remove the knockouts. Lead the power supply cables into the enclosure.
2. Install the mounting frame and the wall-mounting enclosure (UPE) deeper than the finished wall surface (i.e. tile thickness plus adhesive thickness). Note: The wall-mounting enclosure is partially covered by the wall surface (e.g. tile)
3. Once the enclosure is firmly installed and the joints are filled, the plaster cover can be removed.

#### Size of the panel and flush-mounting enclosure

##### Typical tile grid

150 mm tile grid= 147 mm tile + 3 mm joint

153 mm tile grid= 150 mm tile + 3 mm joint

##### Calculation of the panel size

Panel dimension = number of tiles x tile grid - one joint width

Example:

Panel dimension = 2 x 150 mm - 3 mm

Panel dimension = 297 mm

##### Calculation of the flush-mounting enclosure size

Flush-mounting enclosure dimension= Number of tiles x tile grid - one joint width + 10 mm

Example:

Flush-mounting enclosure dimension= 2 x 150 mm - 3 mm + 10 mm

Flush-mounting enclosure dimension= 307 mm



Drawing no9800268

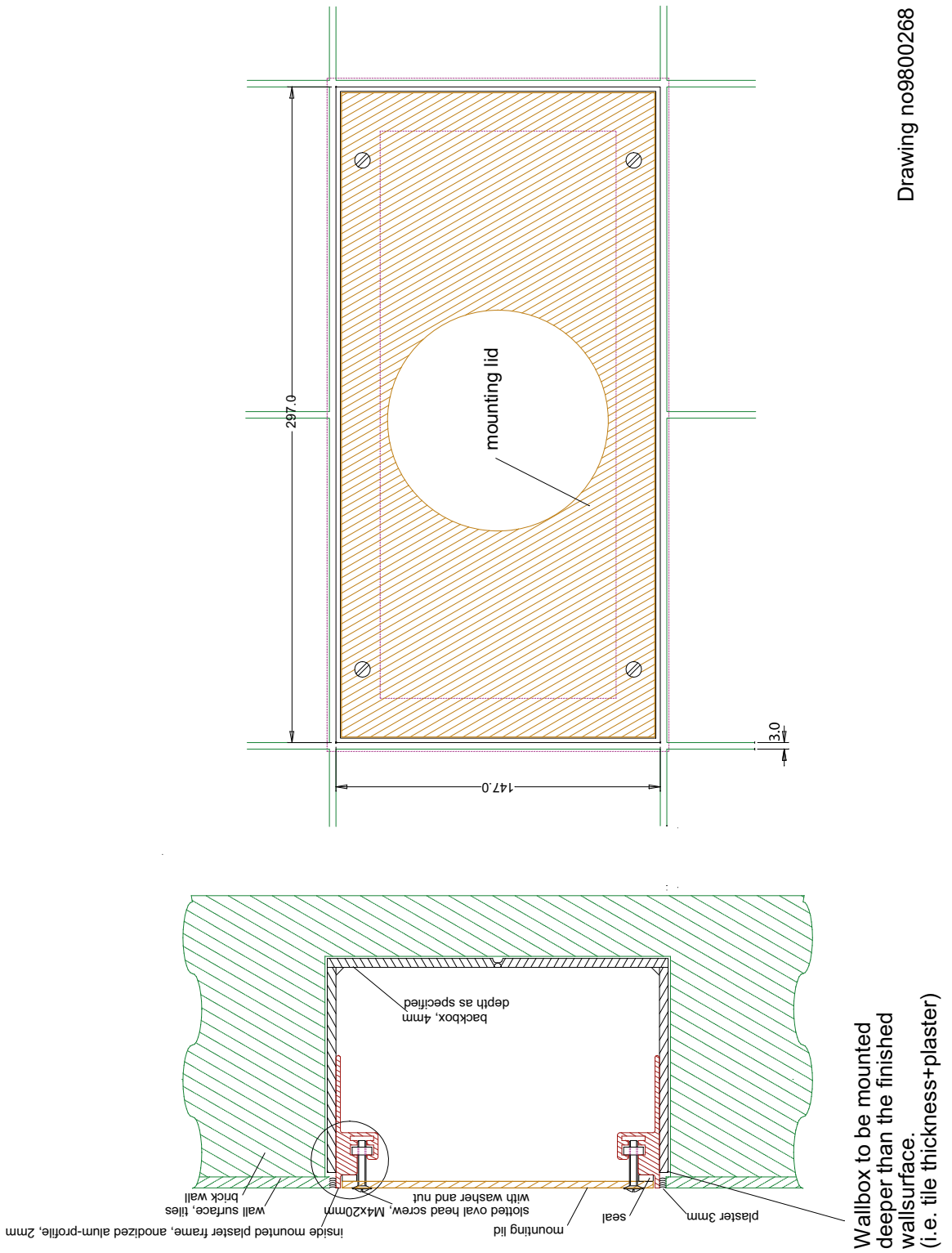

**4.1.5 Mounting the front plate**

The front plates are fitted into the flush-mounting enclosure and are marked with a number that is identical to the number of the enclosure. The front plate number must be identical to the enclosure number!

Install the hinges of the front plate as described in the drawing below:

**4.1.5.1 Flush-mounting type enclosure with bezel frame (UPB)**

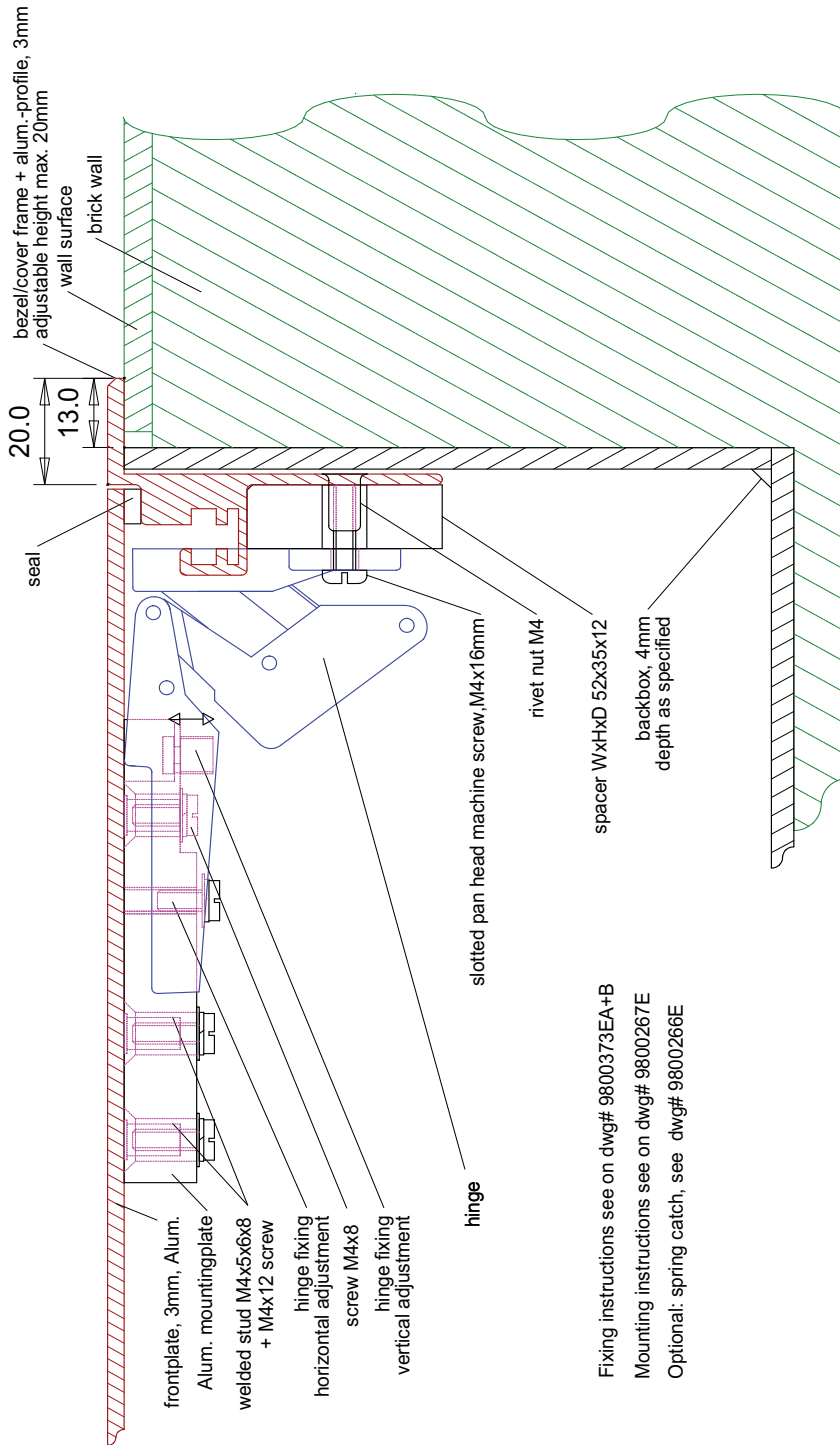

Drawing no.: 9800269

4.1.5.2 Flush-mounting type enclosure with mounting frame (UPE)

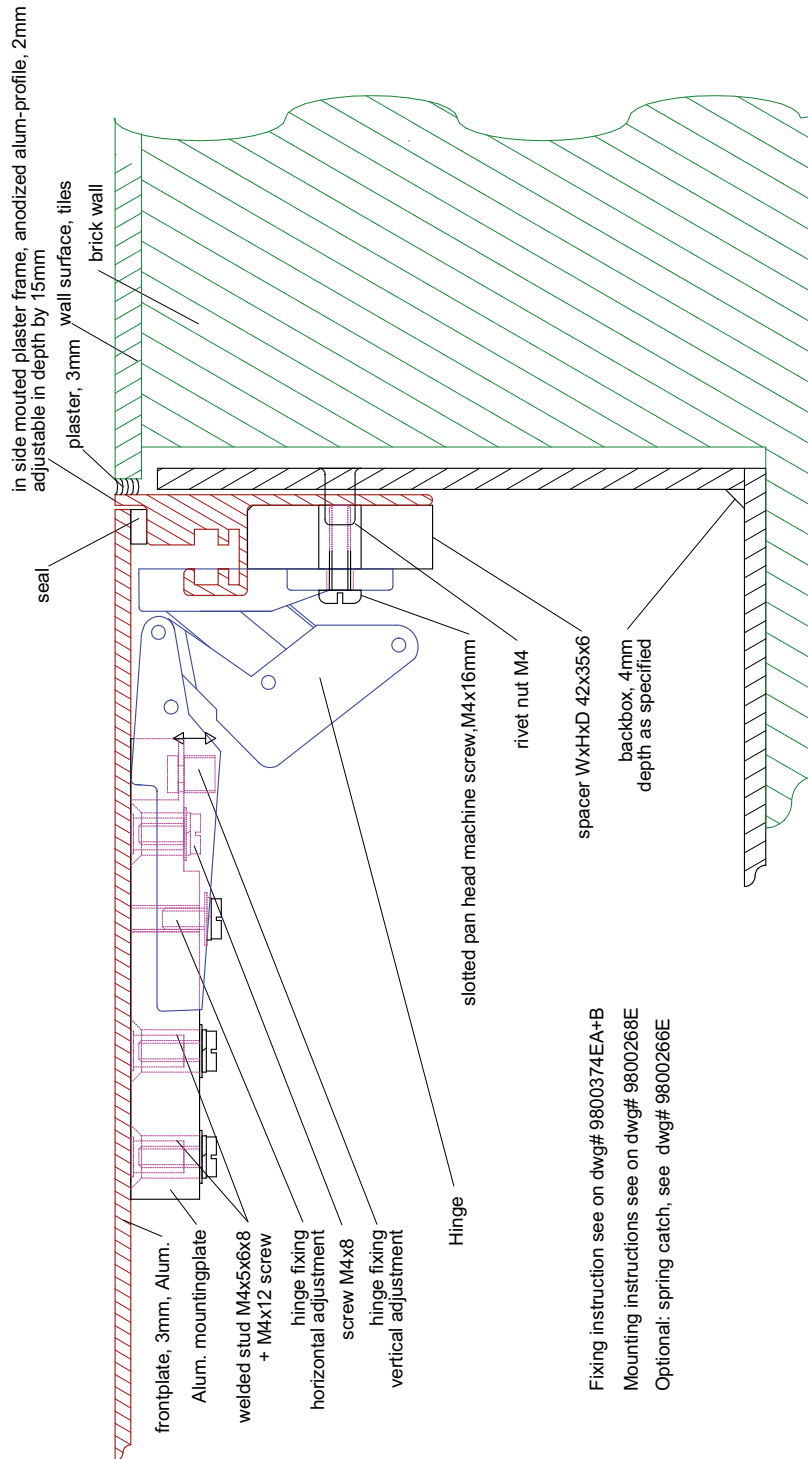

Drawing no.: 9800272

**4.1.6 Installation of the surface-mounting enclosure (AP)**

1. Open the front plate as described in chapter "4.1.7 Opening the front plate".
2. Drill holes into the enclosure for wall mounting and cable entries. The holes are not pre-drilled so that local conditions can be considered. However, you must ensure that the cables are positioned in such a way that there is enough space left for the circuit-boards when the frontplate is closed.
3. Fix the enclosure to the wall using stainless screws.
4. Lead the power supply cables into the enclosure.

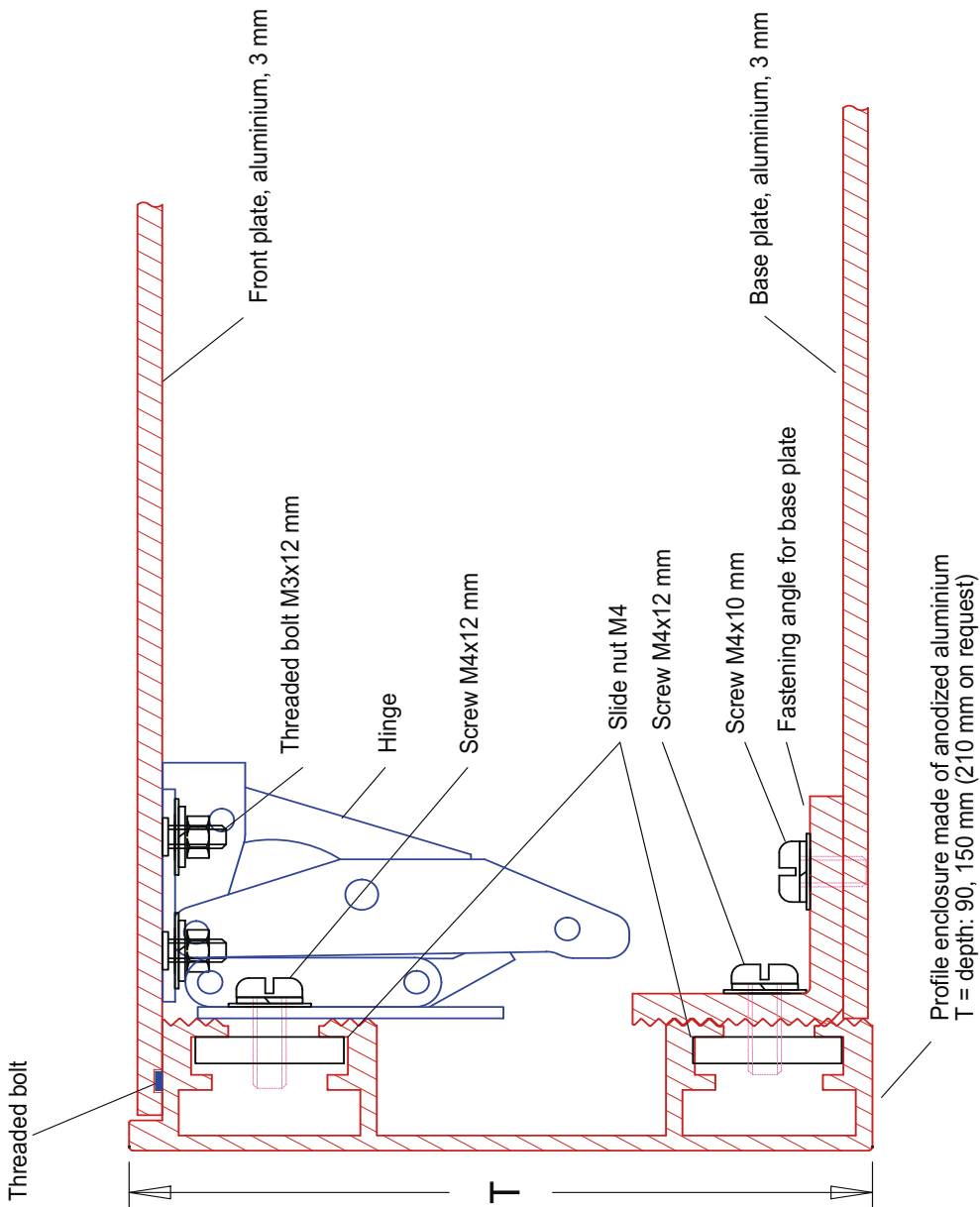

Drawing no.: 9800274

### 4.1.7 Opening the front plate

It should only be possible to open the enclosure with a keys or a tool (as, for example a suction cup, screw driver). This is required by the following standards:

- VDE 0660, part 500, chapter 7.4.2.2.3. a)
- EN 60439-1, chapter 7.4.2.2.3. a)
- IEC 60439-1, chapter 7.4.2.2.3. a)

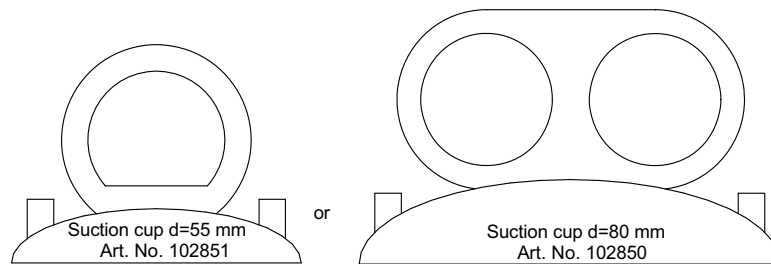

For following wallboxes:

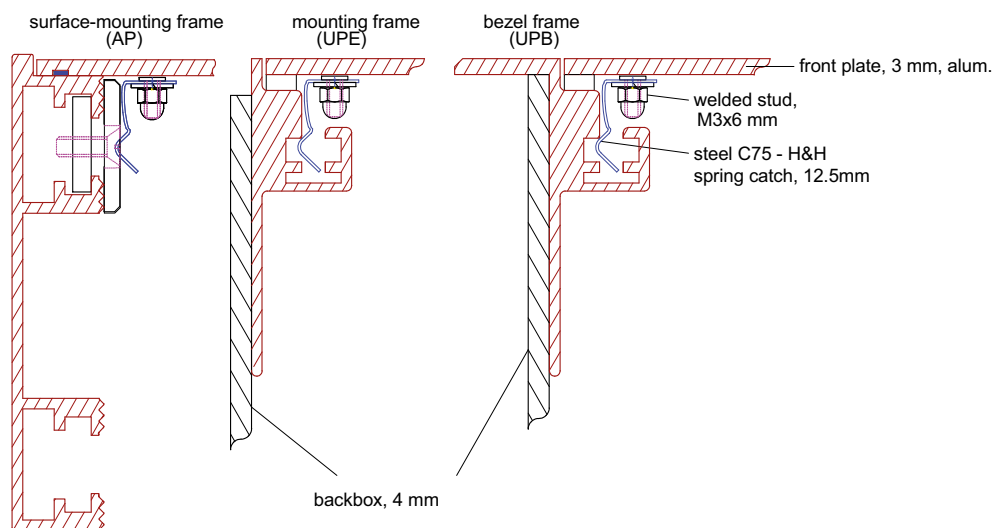

Drawing no.: 9800266



*Factory-delivered, TM800 panels come with a textile lug that protrudes between the frame and the front plate. This allows the front plate to be opened for commissioning without the use of a tool. Make sure this textile lug no longer protrudes from the enclosure after commissioning.*

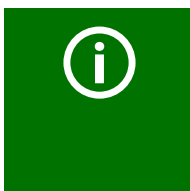

*Components protruding from the front plate (such as socket-outlets, remote operating theatre table control) which could enable the user to hold on to them and to open the alarm indicator and operator panel are secured by means of a screw located in the middle of the side opposite the hinges:  
Raised countersunk head screw, M4x10 with rosette.*

## 4.2 Connection



### **Risk of electric shock!**

Before fitting the enclosure and working on the device connections, make sure that the **power supply has been disconnected**.

Failure to comply with this requirement will expose personnel to the risk of an electric shock. Furthermore, the electrical installation may be damaged and the device destroyed beyond repair.



Connect the TM800 alarm indicator and operator panel exclusively according to the wiring diagram supplied with the device. Do not make **any changes to the internal wiring**. Wiring not conforming to the accompanying diagram or unauthorised modifications may result in the TM800 malfunctioning or completely failing to operate.



If inductive loads and the TM800 share a common voltage source, it is absolutely necessary to use flyback diodes directly at the inductive load. Always use a separate power supply for the operation of impulse relays in order to avoid interferences.



Make sure that the power supply of the TM800 **is isolated against PE**. If this is not taken into account and a personal computer is connected to the USB interface the TM800 or the personal computer may be damaged.



The device contains components that can be damaged by **electrostatic discharges (ESD)**. If work requires the opening of the device, the safety precautions concerning the dissipation of electrostatic electricity have to be observed.

### 4.2.1 Connection details

The following connections are available on modules installed in the lower part of the enclosure:

- Connect the supply voltage to the terminals 0 and 230 V of the TM800's power supply unit. The standard supply voltage is AC 230 V.
- The terminals for the digital inputs, the open collector outputs and the relay outputs are available on the associated I/O modules BMI8/8, BMI8/4, BMI0/4. Use cables with a cable cross section of at least 0.75 mm<sup>2</sup> for the connection of digital inputs and relay outputs. The maximum cable length per connection is 500 m.
- A terminal board allows the connection to the internal and external BMS bus (internal bus = terminals iA/iB, external bus = terminals eA/eB). Connect the BMS bus according to the instructions in chapter "4.2.3 BMS-bus connection" and in the "BMS bus" leaflet. Use a shielded cable of at least mm or 0.8 mm cross section for the interface line (e.g. J-Y(St)Y n x 2x0.8). The terminals iS resp. eS are used to connect the shield of the respective BMS bus. The shield must be connected to earth at one end. The shield may in no circumstances be earthed at several points.

4.2.2 Modules and connections of the TM800 (connection example)

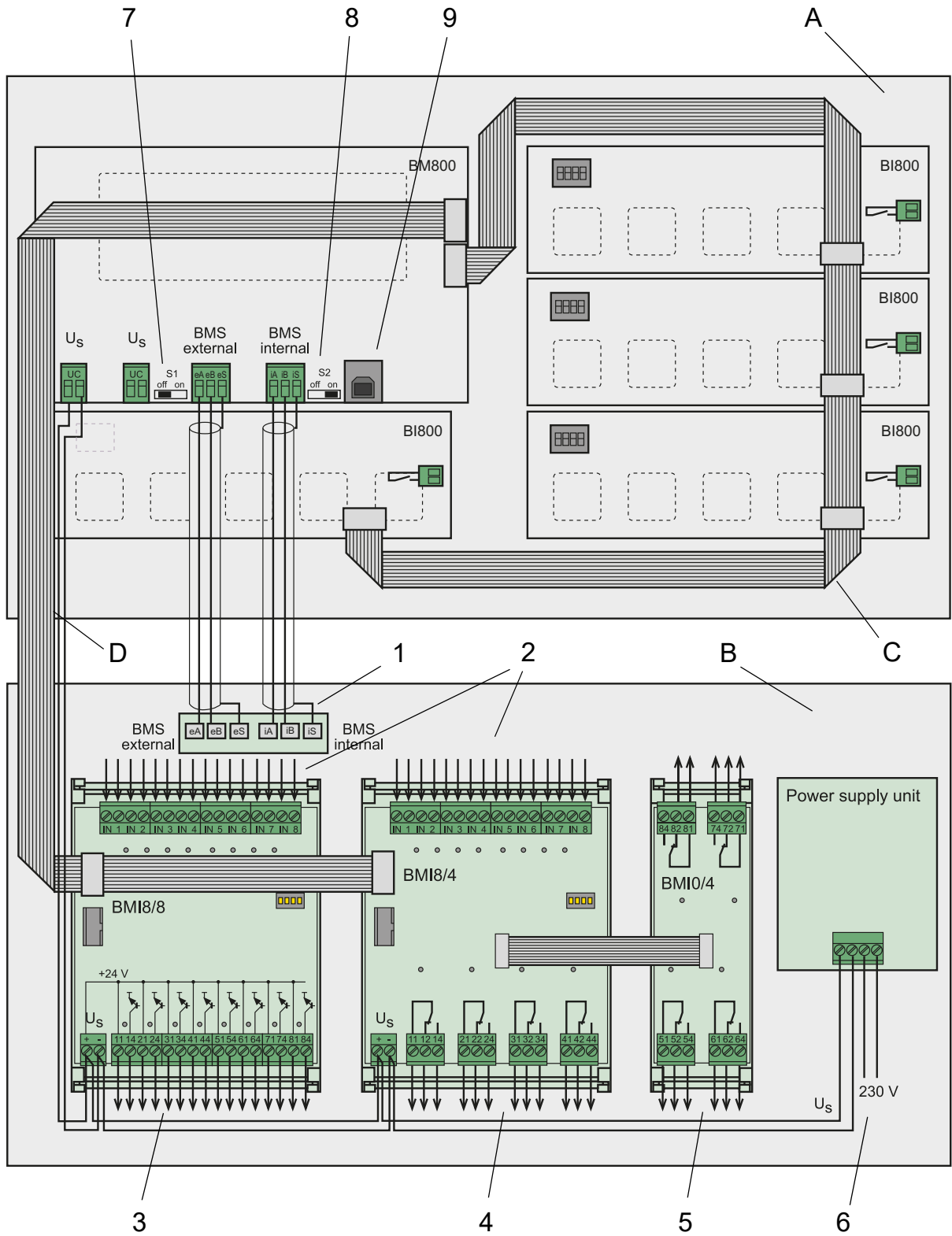

**Legend to wiring diagram**

A	Back of the front plate
B	Mounting plate, installed in the bottom part of the enclosure.
C	I <sup>2</sup> C bus, is used for communication between the modules BM800 (resp. BM400) and the operating and display modules BI800S. The terminals of the two I <sup>2</sup> C buses must not be interchanged!
D	I <sup>2</sup> C bus, is used for communication between the modules BM800 (or BM400) and the I/O modules BMI8/8, BMI8/4 and BMI0/4. The terminals of the two I <sup>2</sup> C buses must not be interchanged!
1	Terminal board for connection to the internal and external BMS bus (internal bus = terminals iA, iB, iS, external bus = terminals eA, eB, eS)
2	Digital inputs of the I/O module BMI8/4, or BMI8/8
3	Open collector outputs of the I/O module BMI8/8
4	Relay outputs of the I/O module BMI8/4
5	Relay outputs of the I/O module BMI0/4
6	Connection of the supply voltage $U_S$ to the terminals 0 and 230 V of the power supply unit. The standard supply voltage is AC 230 V.
7	Switch S1 to terminate the external BMS bus.
8	Switch S2 to terminate the internal BMS bus.
9	USB connection for programming purposes. Cable: Type A plug on type B plug.

**TM800 modules**

BM800	Module
BI800S	Operating and displaying module to expand each BM800/BM400 module by five pushbuttons
BMI8/8	8 digital inputs, 8 open collector outputs. The open collector outputs are capable of driving a load of up to 15 W, at an operating voltage of 24 V. They feature flyback diodes for the connection of relays.
BMI8/4	8 digital inputs, 4 relay outputs The digital outputs correspond to those of the BMI8/8 module. The potential-free output relays feature one changeover contact of AC 250 V, 5 A (AC1) each.
BMI0/4	Expansion for BMI8/4 by 4 additional relay outputs. The BMI0/4 module can only be used in conjunction with BMI8/4. The potential-free output relays feature one changeover contact of AC 250 V, 5 A (AC1) each.
Mains Part	Power supply unit of the TM800 alarm indicator and operator panel.



### 4.2.3 BMS-bus connection

Communication between the TM800 alarm indicator and operator panel and other system components takes place via two serial interfaces (internal and external BMS bus). These interfaces cables are of two-wire design. See "BMS bus" instruction leaflet for more details about the BMS bus.

The number of bus devices is limited to 30. Install a DI-1PSM repeater if you want to use more devices on the BMS bus. A DI-1PSM also is required when the BMS bus segment of 1200 m is exceeded.

#### 4.2.3.1 Terminating resistor



*Missing or incorrectly installed terminating resistors (e.g. in the middle of the bus) will cause bus instability.*

The BMS bus must be terminated at both ends with terminating resistors of 120  $\Omega$  (0.4 W). One terminating resistor is installed in each TM800 for the internal and external bus.

If several TM800 alarm indicator and operator panels are connected via the BMS bus, the terminating resistors of the TM800 alarm indicator and operator panels which are not installed at the end of the bus have to be switched off. The same applies to all other devices and modules that are not installed at the end of the bus.

Use the DIP switches S1 and S2 to set the terminating resistor for the internal and external BMS bus: S1 = external BMS bus; S2 = internal BMS bus. Factory setting: S1 and S2: off. The DIP switches are located on the BM800 module adjacent to the interface terminals. Use the DIP switch to select on or off position.

#### BMS-bus addresses

Be sure that the addresses of all devices connected to the bus are correctly assigned. Never assign one address twice. Assign the addresses consecutively without any gaps. Bear in mind that each bus requires one master. A device becomes a master by assigning address 1 to it. Address assignment can be carried out via the menu of the TM800 alarm indicator and operator panel (see "Settings menu 10: Interface" on page 65) or via the basic settings in the TMK-SET software.

#### Internal BMS bus

Select an address between 1 and 150 for the internal bus of the alarm indicator and operator panel (factory setting: 1). The addresses 100...103 are reserved for special tasks (e.g. programming). This setting can only be changed when the external bus has been switched off before. On the internal BMS bus the baud rate is set to a fixed value of 9600 bits/s.

#### External BMS bus

Select an address between 1 and 99 for the BMS bus of the TM800 alarm indicator and operator panel.

The external bus is primarily used for the connection of several TM800 alarm indicator and operator panels. But also MK800 alarm indicator and test combinations and SMI472-12 signal converters can be connected. Up to 99 devices can be connected.

The following applies to the external bus:

- When the TM800 alarm indicator and operator panel is the only control device in the system, address 1 (Master) is assigned to it.

- On the external bus, the Master function can be cyclically passed from one address to the next higher one.



*The addresses are consecutively assigned to additional TM800 alarm indicator and operator panels (2, 3 etc.). Only when there are no gaps between the addresses, reliable function can be ensured.*

*All devices on the external bus must be equipped with compatible software versions (see chapter "3.3.6").*

*All devices must be set to the same baud rate.*

### 4.3 Examples for connection and address assignment

#### Example Devices on the internal bus

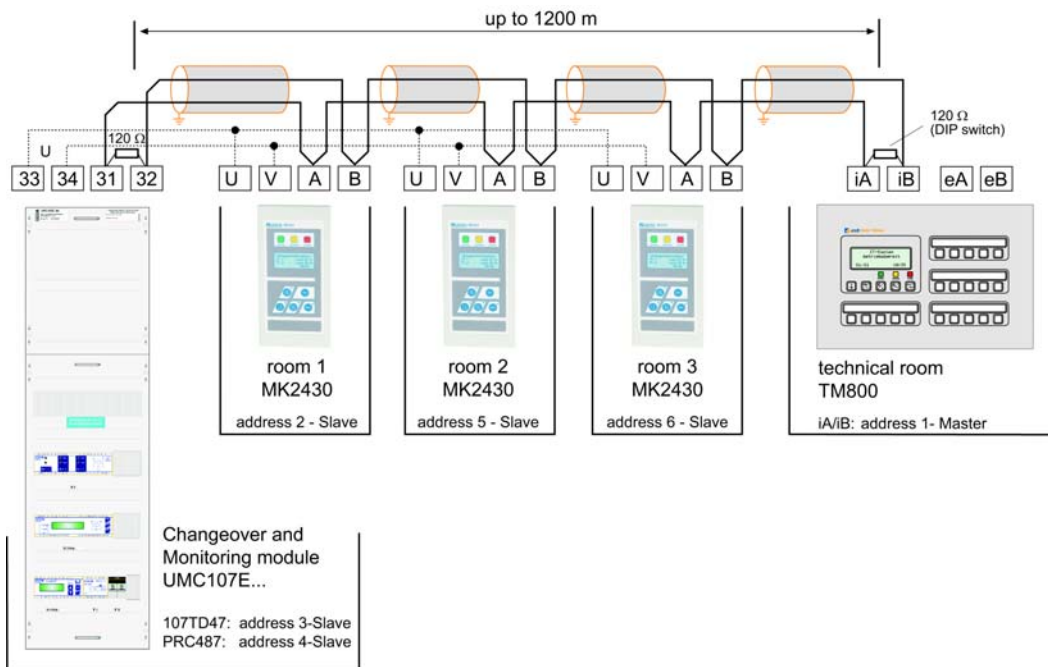

*Changeover and monitoring module UMC107E-... with alarm indicator and operator panel TM800 and 3 alarm indicator and test combinations MK2430. All components are connected to the TM800 via the internal RS-485 interface.*

Example 2: Parallel operator panel

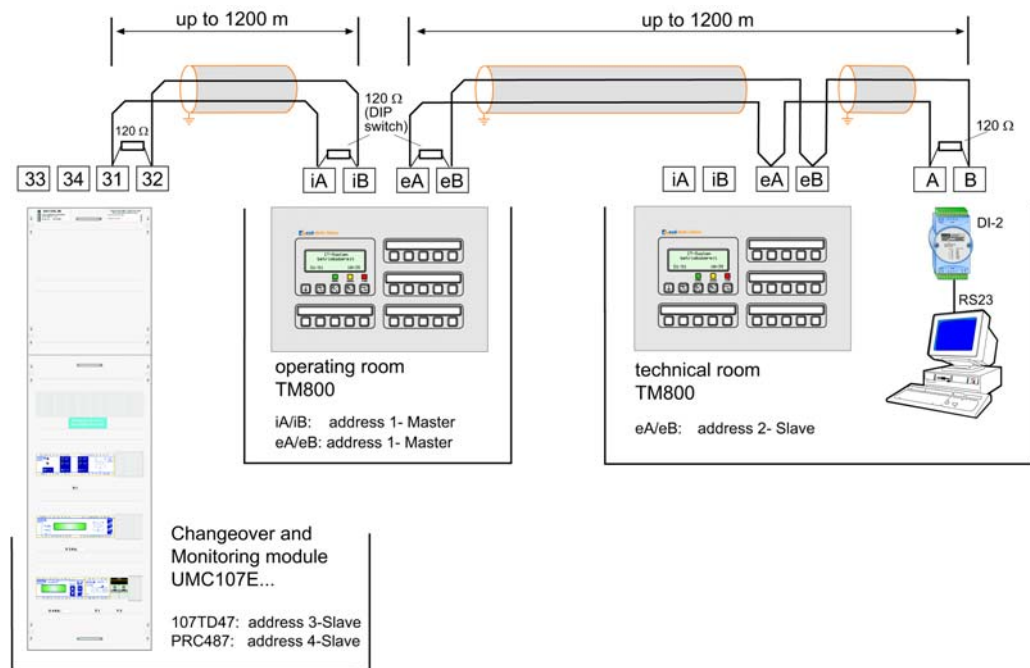

Changeover and monitoring module UMC107E-... with an alarm indicator and operator panel TM800 in an operating theatre, a "higher-level" alarm indicator and operator panel TM800 in the technical control room and a personal computer to evaluate the history memory of the alarm indicator and operator panels. If the personal computer does not have an RS-485 interface, an RS-232/RS-485 converter DI-2 or a USB/RS-485 converter DI-2USB will be required.

Example 3: Central devices on the BMS bus

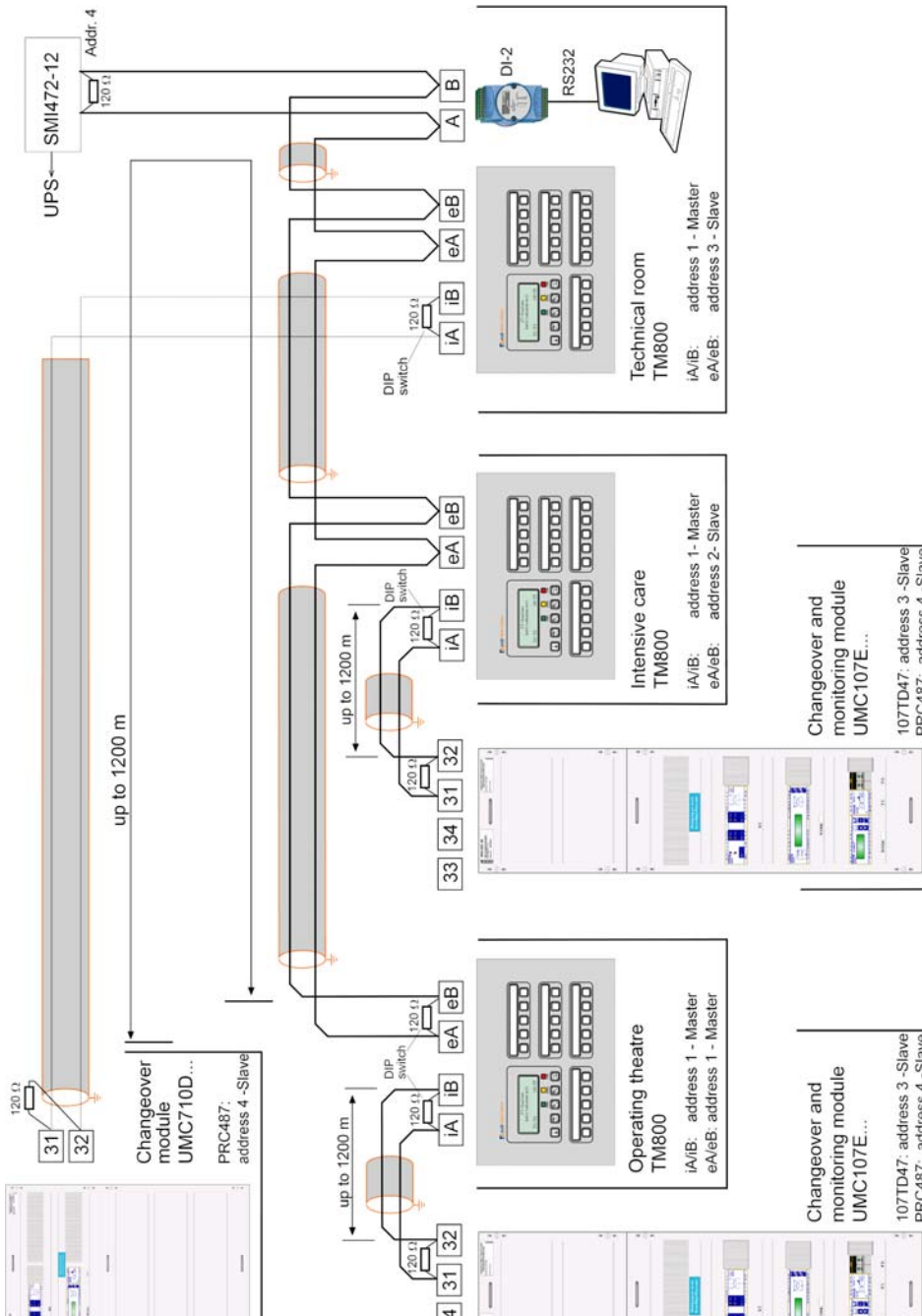

A three or four-pole changeover module UMC710D- with two changeover and monitoring modules UMC107E downstream and messages from the UPS (battery-supported safety power supply) system. Each UMC107E is connected to "its" alarm indicator and operator panel TM800 via the internal BMS bus. The TM800 panels are connected with each other and also to a "higher-level" TM800 in the technical room, to the SMI472-12 converter module and to a personal computer for the evaluation of the history memory via the external BMS bus. If the personal computer does not have an RS-485 interface, an RS-232/RS-485 converter DI-2 or a USB/RS-485 converter DI-2USB will be required.

### 4.3.1 Address settings and their meaning

Display		Meaning	Setting on TM/MK800	Setting on TMK-SET
External address	Internal address			
0 (ext. bus on)	0	--	--	--
0 (ext. bus on)	1	TM/MK itself	--	dig. IN*
0 (ext. bus off)	M = own addr.	TM/MK itself	--	dig. IN*
0 (ext. bus off)	M <> own addr	Device M on the int. bus of the own device	ext: 0/int: M	int. bus: int M
N = own addr.	0	Device N on the external bus	--	dig. IN*
N = own addr.	1	TM/MK itself	--	dig. IN*
N = own addr.	M > 1	Device M on the int. bus of the own device	--	int. bus: int M
N <> own addr.	0	Device N on the external bus	ext: N/int: 0	ext. bus: ext: N, int: 0
N <> own addr.	1	Device N on the external bus	--	ext. bus: ext: N, int: 0
N <> own addr.	M > 1	Device M on the int. bus of device N	ext: N/int: M	ext. bus: ext: N, int: M

**Explanatory note to the digital inputs (\*)**

Alarm messages from digital inputs on TM/MK800 are always displayed on the device itself regardless of whether an individual message has been programmed or not (Exception: channel is deactivated).

An entry into the alarm address table is not required.

- If no individual message is programmed, the standard text will be displayed.
- An alarm message can also be programmed to be displayed without text/LED/buzzer (**silent message**).
- **Note: Flashing alarm messages are not allowed!**

In principle, all alarm messages are stored in the history memory (Exception: channel is deactivated):

- If no individual message is programmed, the standard text will be displayed resp. will be stored in the history memory.
- If the message has been programmed without a text (silent message), its source (DigIn resp. address and channel No.) will be stored in the history memory (no individual text possible!).
- Test messages are only stored in the history memory of the device that triggered the message.

**Transmission via BMS bus:**

- All alarm messages are actively sent (i.e. as a new message) via the external or internal BMS.

Operating messages are actively sent via the external BMS bus and are not stored in the history memory.

- Note: Flashing messages must be avoided, where possible, and on no account be sent via the int./ext. BMS bus!
- The first 16 digital inputs can be configured as "flashing" and in this case are not signalled via the external BMS. This is only permissible for messages with a flashing frequency of 0.5 Hz!

Inputs that are assigned to operating messages or switching commands are not displayed with a text message or stored into the history memory.

## 5. Commissioning and testing

Start commissioning according to the following commissioning pattern:

1. Tests before switching on
2. Tests after switching on
3. Set parameters (parameterisation)
4. Settings at the TM800
5. Settings in the TMK-SET software
6. Tests after parameter setting



*Write down all settings and keep it together with the device and installation documentation.*

*When setting the TM800 with the configuration software TMK-SET, a project file will be created. Save this file. Create a backup copy of this file and keep it in a safe place.*

### 5.1 Tests before switching on

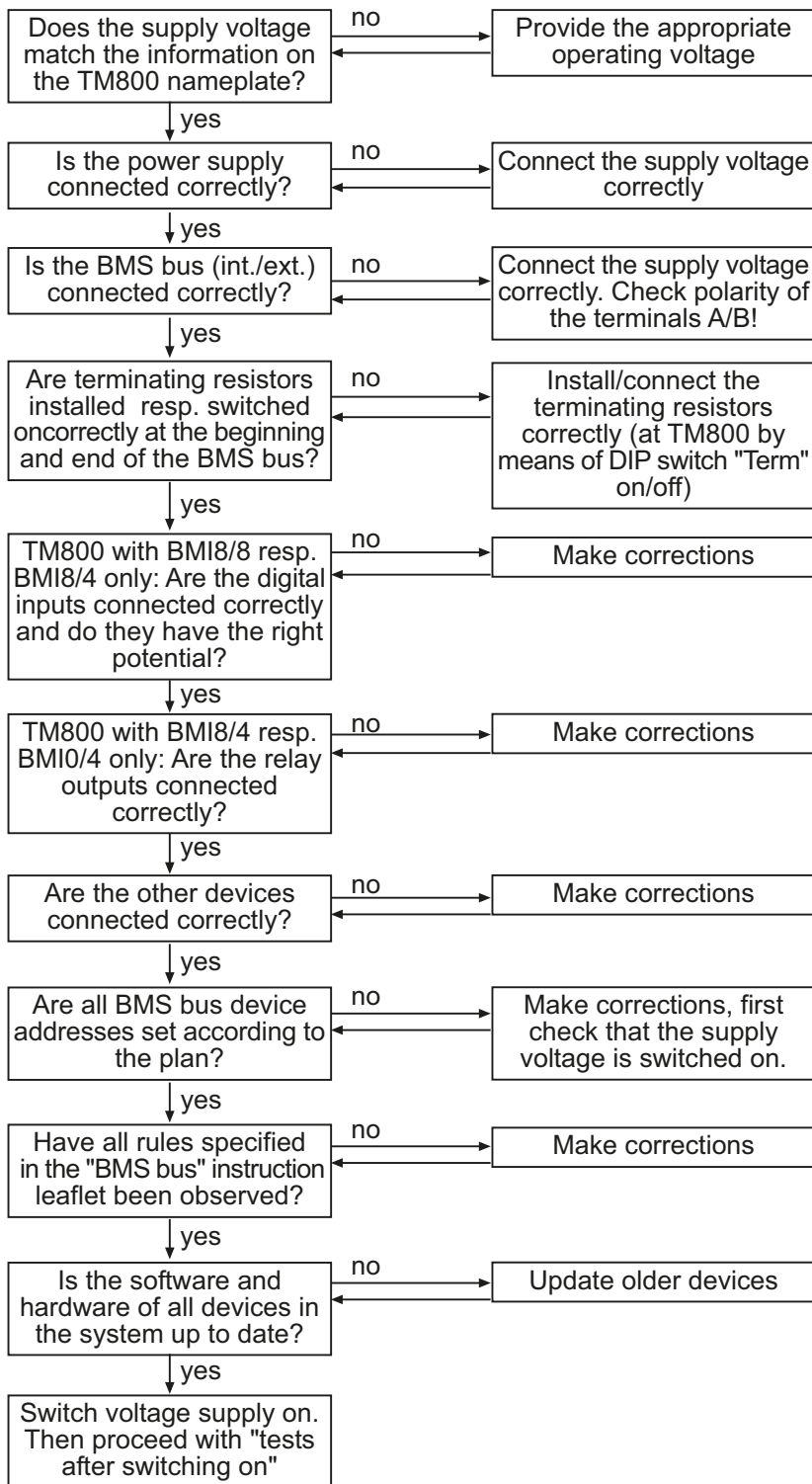

Continue with chapter "Tests after switching on" on page 39.



## 5.2 Tests after switching on

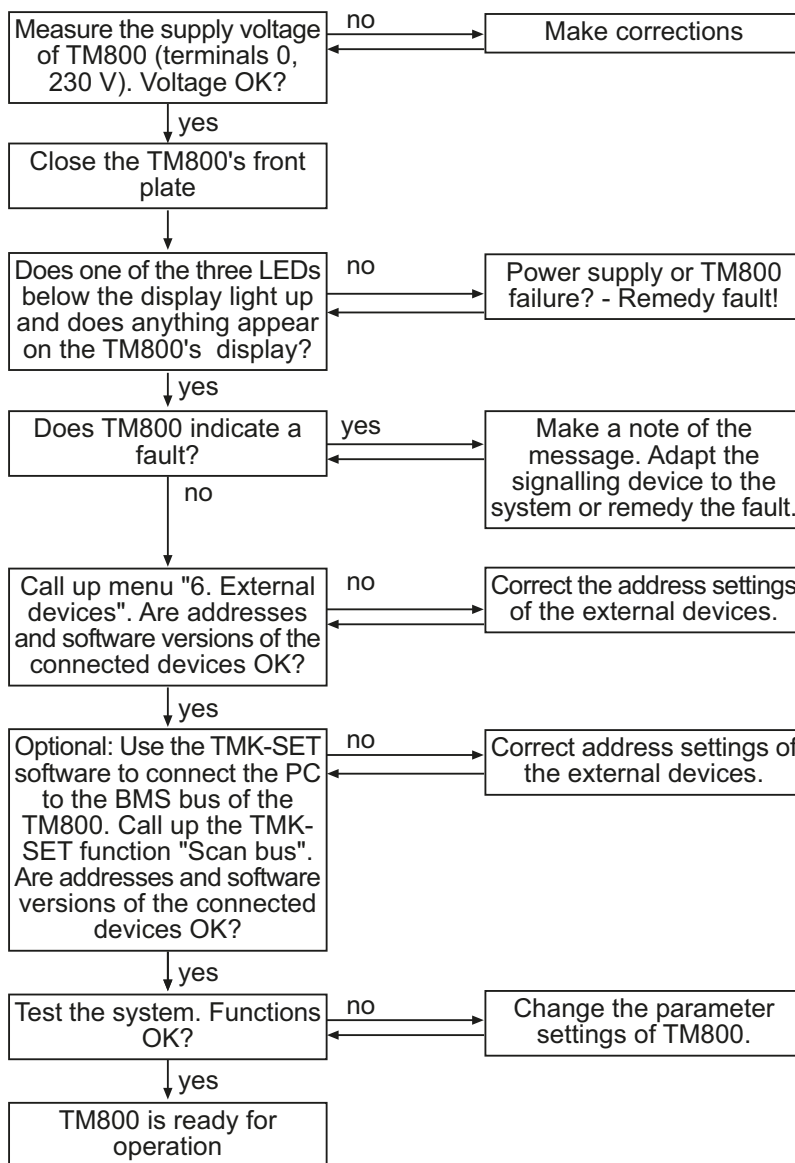

Continue with chapter "Make settings (parameterisation)" on page 39.

## 5.3 Make settings (parameterisation)



**All** settings can be carried out using the TMK-SET software. Alternatively, some settings can be carried out via the TM800 menu (see diagrams).

**5.3.1 Settings at the TM800**

The following settings can optionally be carried out via the function buttons at the TM800 or the TMK-SET software. Make a note of the modified settings (setting table).

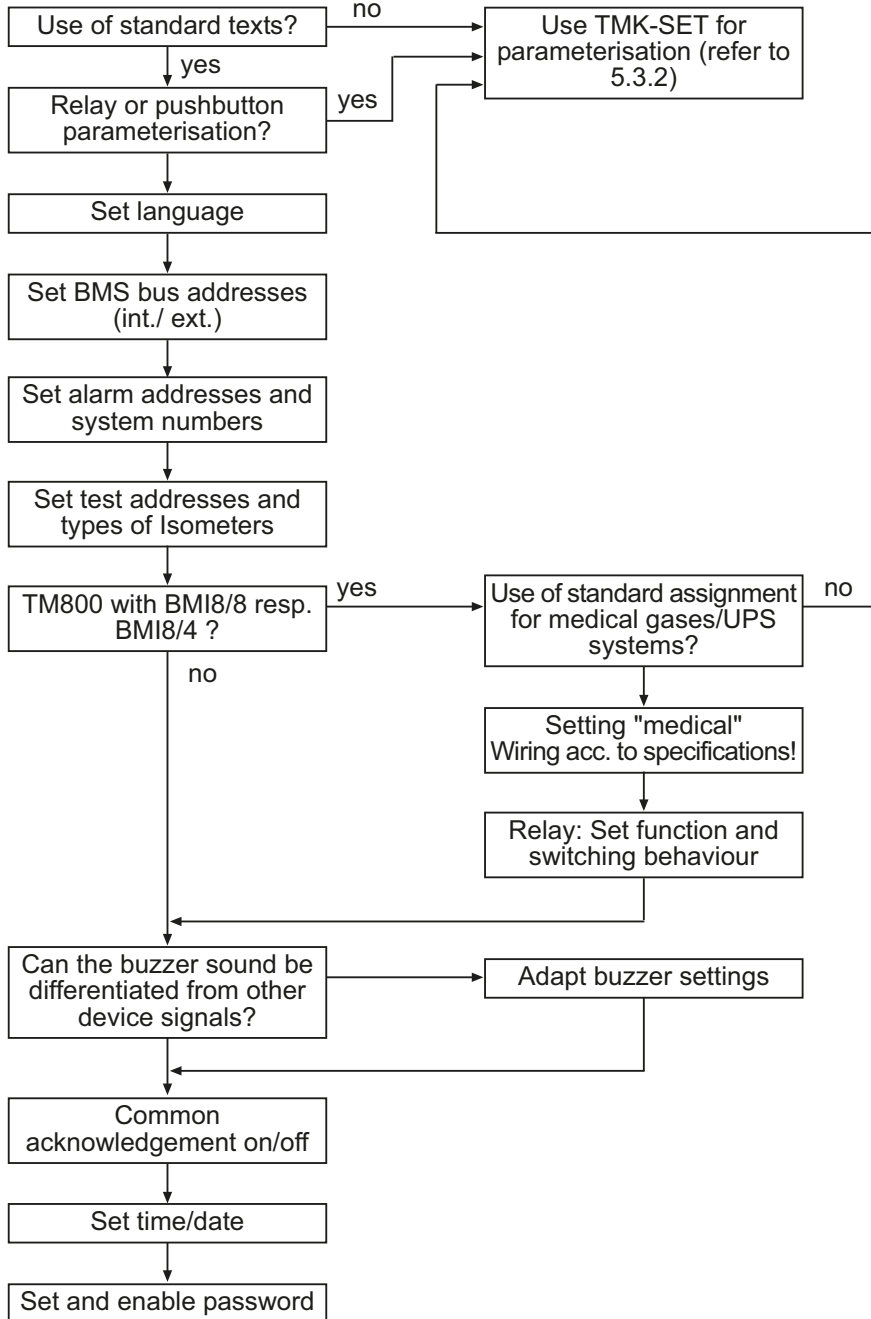

Continue with chapter "Tests after parameter setting" on page 42.

### 5.3.2 Settings using the TMK-SET software

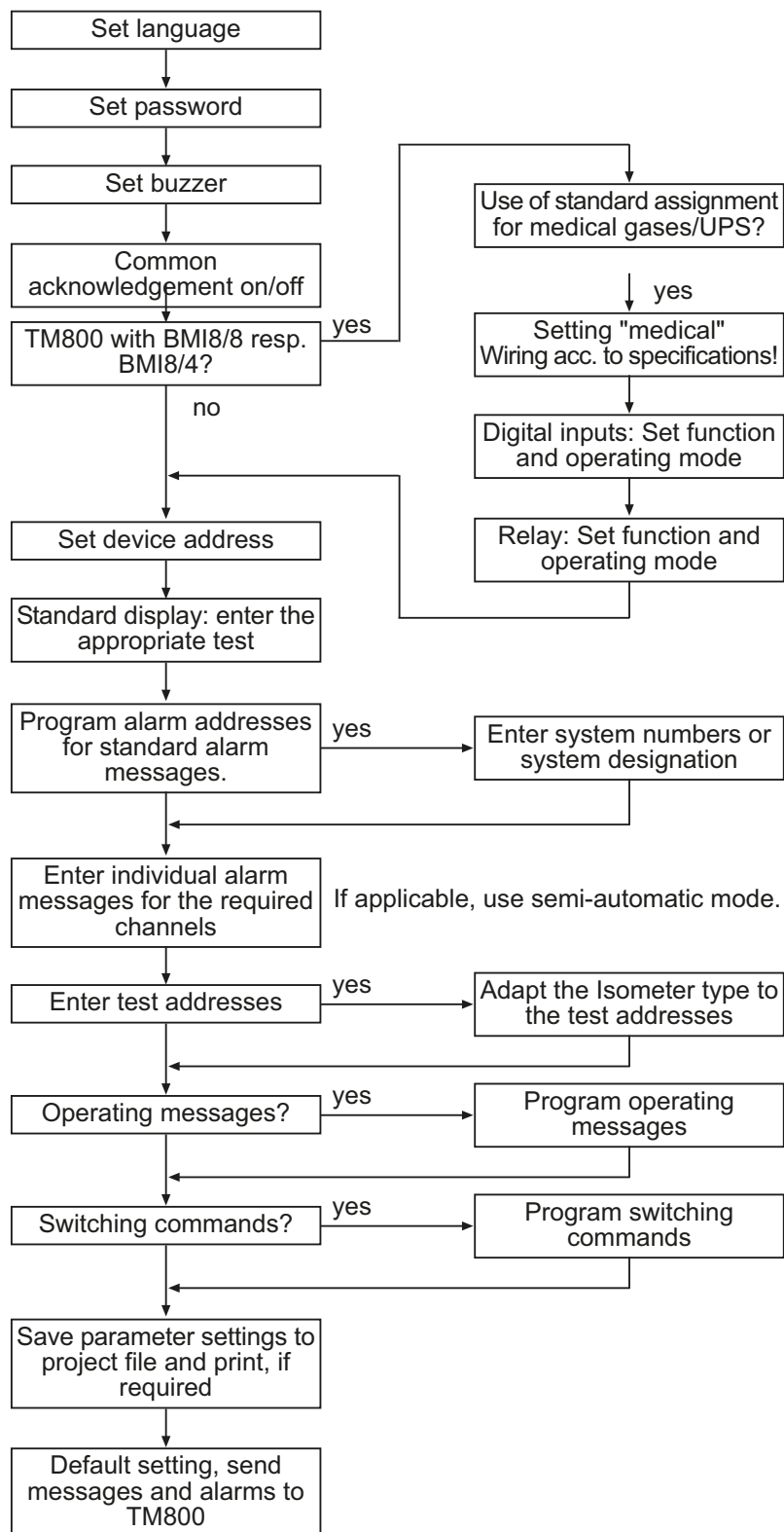

Continue with chapter "Tests after parameter setting" on page 42.

5.3.3 Tests after parameter setting

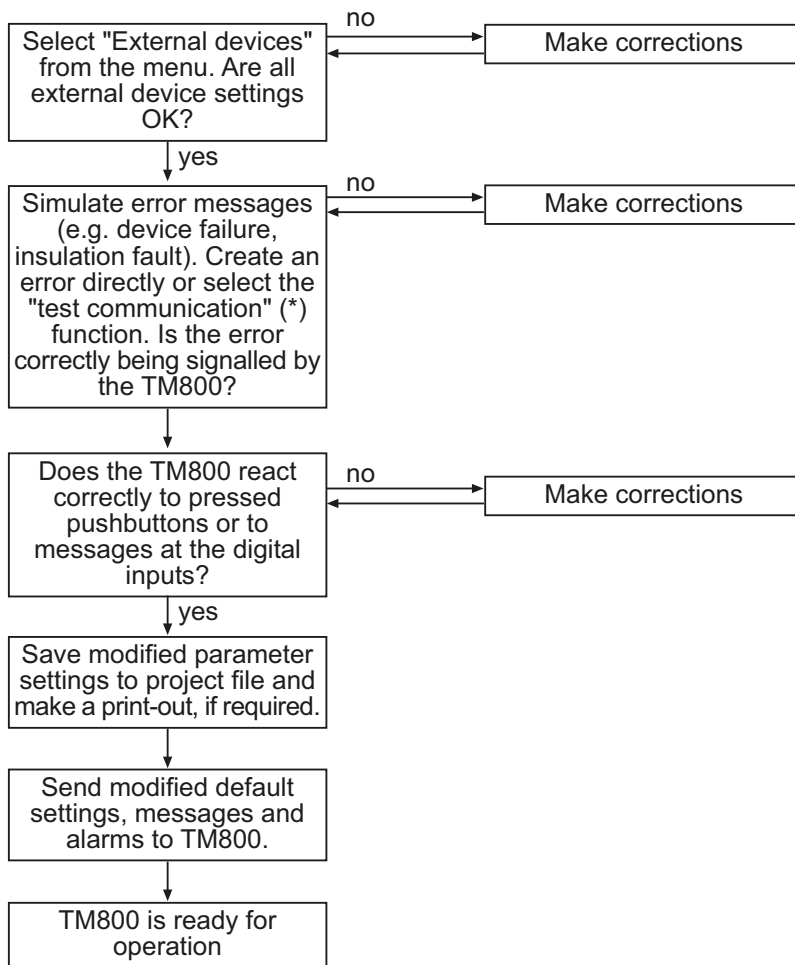

(\*) Messages which can be created by a BMS device are simulated.

## 5.4 Periodic verification and service

### 5.4.1 Periodic verification

The following periodic verifications of electrical installations have to be carried out according to the local or national standards effective at the time of installation. For your Bender products, we recommend:

Task	By	Interval
Functional test of IT system monitoring (insulation, load current, transformer temperature and connection monitoring) by pressing the test button on the alarm indicator and test combination or on the alarm indicator and operator panel.	Medical personnel	Once every working day
Functional test of the transfer switching device*: Functional test of the automatic transfer switching device. Follow the instructions in chapter "Testing of the transfer switching device!"	Electrically skilled person	Once every six months
Functional test of the IT system monitoring (insulation, load current, transformer temperature and connection monitoring) on the insulation monitoring device.	Electrically skilled person	Once every six months
Test of the setting values and the changeover periods	Electrically skilled person	Once every 12 months
Test of the transfer switching device, the IT system monitoring, and the connection to the SCADA system (Supervisory Control and Data Acquisition) (if applicable) and the interaction between the components in the system. The test includes the following: - Inspection: Marking, display elements, mechanical components, wiring, parameterisation, connection of third-party equipment, evaluation of the fault memory - Measurement: Internal/external supply voltages/potentials, bus voltage, bus protocol, bus scan - Testing: Device function, device communication. - Documentation: Test results, recommendations for elimination of defects.	Bender-Service	Once every 24 months

\* *This test must only be performed by an authorised electrically skilled person in agreement with the medical locations concerned.*

Before carrying out the tests, please refer to the instructions relating to the functional tests in the check list. If no national directives apply, you should perform the tests recommended by IEC 60364-7-710: 2002-11, section 710.62 and DIN VDE 0100-710 (VDE 0100 Part 710):

### 5.4.2 Service

For technical support, commissioning, troubleshooting and periodic verification Bender offers:

#### First Level Support

Technical support by phone or e-mail for all Bender products:

- Question about specific customer applications
- Commissioning
- Troubleshooting

Telephone: +49 6401 807-760\*

Fax: +49 6401 807-259

In Germany only: 0700BenderHelp (Tel. and Fax)

E-mail: support@bender-service.com

#### Repair Service

Repair, calibration, update and replacement service for all Bender products

- Repair, calibration, testing and analysing Bender products
- Hardware and software update for Bender devices
- Delivery of replacement devices for faulty or incorrectly delivered Bender devices
- Extended warranty for Bender devices with in-house repair service resp. replacement devices at no extra cost

Telephone: +49 6401 807-780\*\* (technical issues)

+49 6401 807-784\*\*, -785\*\* (commercial issues)

Fax: +49 6401 807-789

E-mail: repair@bender-service.com

Please send the devices for repair to the following address:

**Bender GmbH, Repair-Service, Londerfer Straße 65, 35305 Grünberg**

#### Field Service

On-site service for all Bender products

- Commissioning, parameter setting, maintenance, trouble shooting for Bender products
- Analysis of the electrical installation in the building (power quality test, EMC test, thermography)
- Practical training courses for customers.

Telephone: +49 6401 807-752\*\*, -762 \*\* (technical issues)

+49 6401 807-753\*\* (commercial issues)

Fax: +49 6401 807-759

E-mail: fieldservice@bender-service.com

\*Available from 7.00 a.m. to 8.00 p.m. on 365 days of the year (CET/UTC+1)

\*\*Mo-Thu 7.00 a.m. - 8.00 p.m., Fr 7.00 a.m. - 13.00 p.m.

**Internet: [www.bender.de](http://www.bender.de)**

### 5.4.3 Maintenance

The TM800 alarm indicator and operator panel does not contain any parts that must be maintained. Despite this, the intervals specified for periodic verification should be adhered to.

## 6. Troubleshooting

### 6.1 Error messages

The following errors are recognised by the BM800 module and indicated on the display. The buzzer emits a beep code corresponding to the error number every 10 seconds. If an optional input/output module exists and if the function "device error" is set in the "Relay" settings menu, also the digital output 1 will also switch.

No.	Display	Description	Task
1	DISPLAY ERROR	Display defective	Replace BM800 module*
2	I <sup>2</sup> C-BUS ERROR(X)	Error code (X): 1 I <sup>2</sup> C bus error 2 Ack error when sending the address 3 Ack error during data transmission 4 Ack error while receiving the address 5 Ack error while receiving data 6 Communication problem	Interrupt supply voltage to TM800 for ≥ 3 minutes. If the error continues to exist, BM800 module or I <sup>2</sup> Cbus cable is defective -> replace*.
3	RTC ERROR	Clock chip defective	Replace BM800 module*
4	FLASH ERROR	Memory module D5 defective	Replace memory module D5 (socketed), replace BM800 module*
5	Address internal ERROR (XXX)	Address of the TM800 on the internal BMS bus is already occupied (XXX=current address)	Change the address of TM800 in the menu
6	Overflow ERROR (03)	More than 80 alarm messages are present.	Reduce the amount of messages
	Overflow ERROR (05)	More than 1000 device failure messages are present	Reduce the amount of messages
	Overflow ERROR (07)	More than 99 text messages are present	Reduce the amount of messages
	Overflow ERROR (08)	Automatic correction of the history memory is carried out because of voltage interruption.	None
	Overflow ERROR (11)	Stack Error	Make a note of the error code. Contact Bender Service.
7	Checksum ERROR	Program memory defective	Replace BM800 module*

No.	Display	Description	Task
8	Address external ERROR (XXX)	Address of the TM800 on the external BMS bus is already occupied (XXX=current address)	Change the address of TM800 in the menu
9	I <sup>2</sup> C-0-Error	I <sup>2</sup> C-Bus-Interrupt	Replace BM800 module*
10	I <sup>2</sup> C-1-Error	I <sup>2</sup> C-Bus-Interrupt	Replace BM800 module*

\*Please make a note of the cause of error, the error number and if applicable the error code. This information facilitates the diagnosis and repair of the equipment.

## 6.2 Malfunctions

Below please find a selection of errors likely to occur and how to eliminate them. This error list does not claim to be exhaustive. Possible error codes occurring after carrying out a test are listed in the chapter "Test function" on page 52f.

Error	Possible cause	Task
No indication on the display of the TM800 alarm indicator and operator panel.	Check AC/DC 24 V power supply; Check the fuse of the power supply unit.	Replace fuse, if required.
No characters on the display, although the display is illuminated.		Replace BM800 module*
Function buttons do not operate.		Replace BM800 module*
The common alarm LEDs do not perform any function		Replace BM800 module
Character matrix visible on the display, but firmware doesn't run.		Replace BM800 module
Time of day gets lost in case of short-term voltage failure		Replace BM800 module
Error during the execution of a switching command (No. and address of an operating and display module not found).	Interface of the internal I <sup>2</sup> C bus defective; ribbon cable or plug defective; address at the operating and display modules not correctly set or assigned twice via DIP switch.	Replace defective part Change the address.



Error	Possible cause	Task
<p>Error during the transmission of the assignments or basic settings via the USB interface.</p>	<p>Address of the alarm indicator and operator panel not correctly set (menu); alarm indicator and operator panel address does not match the setting in the TMK-SET configuration software; USB cable defective; wrong serial interface (com port) set in TMK-SET software.</p>	<p>Replace defective part Change the setting.</p>
<p>Error during transmission of the assignments or basic settings via the external BMS bus.</p>	<p>Address or baud rate of the alarm indicator and operator panel not correctly set (menu); alarm indicator and operator panel address does not match the setting in the TMK-SET configuration software; address of externally connected devices incorrectly set; incorrect parameterisation with TMK-SET; interface cables A/B mixed up; RS-485 bus incorrectly terminated or not terminated at all; wrong serial interface set in the TMK-SET software.</p>	<p>make corrections</p>
<p>Error on internal BMS bus.</p>	<p>Device addresses on the internal bus incorrectly set; interface cables A/B mixed up; network incorrectly terminated or not at all; incorrect parameter setting with TMK-SET.</p>	<p>Make corrections</p>
<p>Functional error of the output relays.</p>	<p>Incorrect programming of the switching commands with TMK-SET; relay defective.</p>	<p>Make corrections</p>
<p>Functional error of the digital inputs.</p>	<p>Digital inputs not correctly set with TMK-SET. Incorrect connection (does not match pre-assignment). Incorrect setting "neutral/medical". Input defective.</p>	<p>Make corrections or replace</p>

### 6.3 Replace flash memory

Most of the programmed data of TM800 are saved in a flash memory (e.g. standard texts, address tables, switching commands, operating messages). New parameters can be transmitted to the TM800 using the "TMK-SET" software via USB interface or the BMS bus.

If no personal computer is available, there is the possibility to replace the existing flash memory by a factory-set individually programmed flash memory. Proceed as follows:



*Before fitting the device and prior to working on the device connections, make sure that the power supply has been disconnected.*

*If this is not taken into account, there exists the danger of electric shock for the user. Furthermore, the electrical installation may be damaged and the device may be destroyed beyond repair.*



*The device contains components that can be damaged by electrostatic discharges (ESD). When work activities are carried out when the device is open, the safety precautions concerning the dissipation of electrostatic electricity have to be observed.*

1. Interrupt the supply voltage to the TM800.
2. Take appropriate precautions to avoid ESD damage (wearing an earthing strap).
3. Open the TM800 front plate.
4. The flash memory D5 is located above the plug contact for the external BMS bus. Remove the existing flash memory using the supplied extraction tool.
5. Put the new flash memory onto the D5 socket as shown in the drawing. It is essential to consider the alignment when inserting the flash memory: see position of the slanted corner shown in the drawing (X).
6. Press the flash memory straight and evenly into the socket.
7. Switch on the supply voltage of the TM800.
8. Check parameters and make corrections, if required. Particularly check the password setting as well as the parameters of the used digital inputs.
9. Check the function of the TM800.
10. Restart the system.

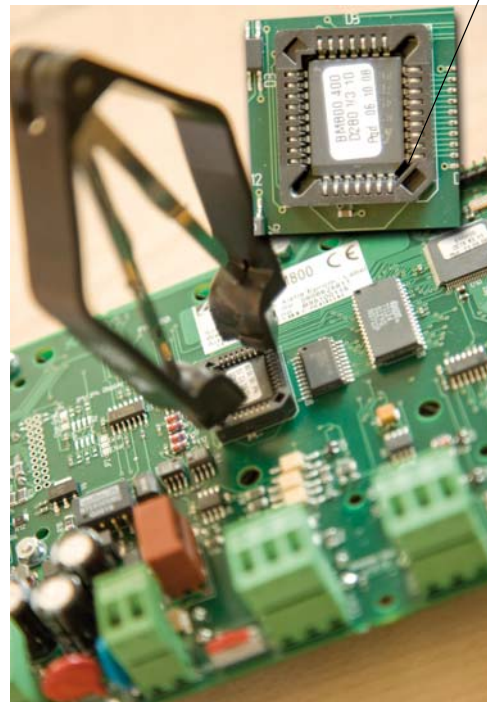

## 7. Operation

This chapter can also be used by the medical personnel as a quick reference guide.

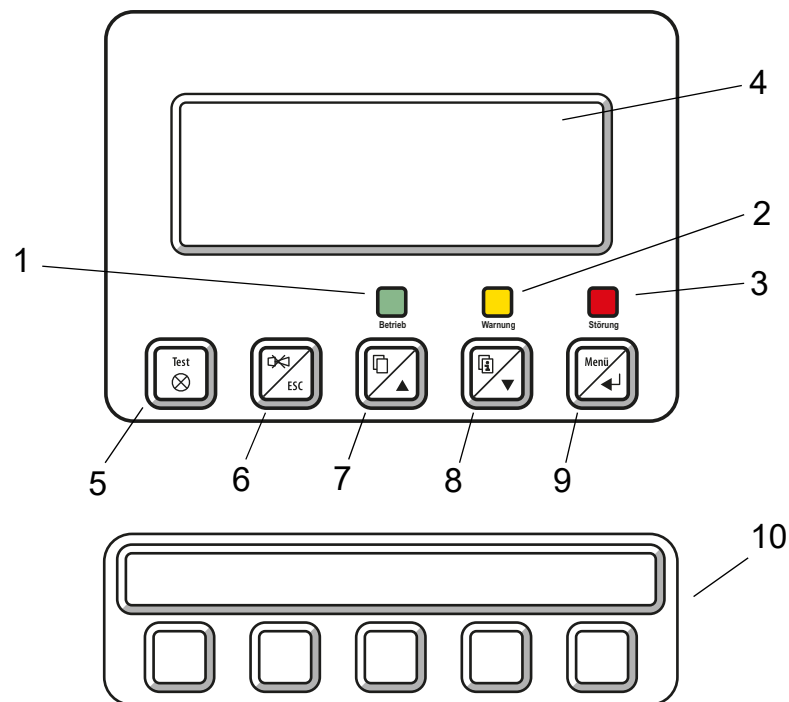

### 7.1 Operator control and display elements



#### LED and LCD

1	LED "Operation": Power On indicator, green (only lights up if no warnings or alarms are pending).
2	LED "Warning" warning messages, yellow
3	LED "Fault": alarm messages, red
4	LCD: Display of operating status, warning and alarm messages as well as menu functions.

The buttons have the following functions:

	In operating mode	In menu mode
5	"TEST" button Press and release: LED test Press and hold down: Trigger the test of assigned devices (insulation monitoring devices, LIM, GFCI).	No function
6	 button (mute button) Mute the buzzer after an alarm message/ acknowledge the alarm.	"ESC" button To mute or deactivate buzzer.
	In operating mode	In menu mode
7	 button (scroll) To scroll through the warning and alarm messages listed on the display.	Arrow button "▲" to move up in the menu.
8	 button (additional text) Toggle between display text and additional alarm text (if available).	Arrow button "▼" to move down in the menu.
9	"MENU" button Starts the menu mode to set the TM800; for display and control functions	"↵" button (Enter button). To confirm the selected menu item.
10	Operating and display module BI800S, BI71S or BI72S. Switching function and/or display function, depending on the programming and/or assignment. Texts and colours freely configurable.	

## 7.2 Quick reference guide

The illustrations below serve as examples.

### 7.2.1 Display under normal operating condition

There are no warnings or alarms pending.

- The green "Normal" LED is lit.
- The LC display shows the programmed standard display.
- A maximum of 3 measuring values can be displayed in lines 1...3.

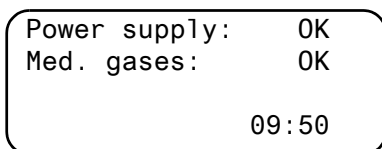

- Line 1...3: User-definable standard display text
- Line 4 Status bar, indicates the time of day (can be switched off).

### 7.2.2 Display during fault condition

A warning or an alarm message exists.

- Depending on the type of fault, either the yellow LED "Warning" or the red LED "Alarm" will light up. The green LED "Normal" no longer lights up.
- The buzzer sounds simultaneously. If the cause of fault cannot be remedied immediately, the buzzer can be muted by pressing the "⊗" (6) button.
- The LC display shows details about the message.

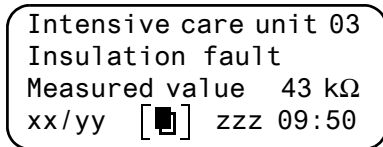

- Line 1: Standard display. "System": Enter user-defined text here: "Intensive care unit 03"
- Line 2...3: Message text, measured value (if available)
- Line 4            Status line
  - xx        = Sequence number of the message displayed
  - yy        = Number of pending messages
  - [ ]        = Message text page, in this case page 1
  - zzz      = Insulation fault location or test currently in progress (see table).09:50= Time (example)

During the insulation fault location or test process, the following displays are possible:

zzz	Meaning
EDSa	EDS insulation fault location in progress (automatic)
EDSp	Continuous EDS insulation fault location in progress
EDSs	Single-pass EDS fault location in progress
EDS	EDS insulation fault location process has been completed, the current measuring sequence is still running.
TEST	Test is running. The message "TEST" flashes if the message being displayed has been caused by the test.

Only when the external bus is in "Off" position:

noMA	No master on the internal bus.
MAST	Device is "substitute master" on the internal bus.

- Press the "Additional text" button (8) to get more information.

```

since: 25:01:12 16:52
Device:      Isometer
Addr/Ch:    003/01
xx/yy  zzz 09:50
    
```

- Line 1: Date and time the message occurred.
- Line 2: Device triggering the message.
- Line 3: Address and channel of the device triggering the message.
- Line 4        Status line
  - xx        = Sequence number of the message displayed
  - yy        = Number of pending messages
  -         = Message text page, in this case page 1
  - zzz       = Insulation fault location or test currently in progress (see table)
  - 09:50    = Time (example)

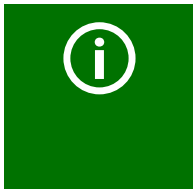

*When the messages are individually programmed, the message text display may vary.  
If messages are pending and one of the arrow buttons is pressed, the latest message will appear on the display. If no further button is pressed, this message will be displayed for 15 seconds.*

### 7.2.3 Test function

Press and hold down the "TEST" button for at least one second to check the function of the assigned insulation monitoring devices (e.g. 107TD47, IRDH...), LIM (Line Isolation Monitors) and GFCI (Ground Fault Circuit interrupters). A message is only output on the TM800 on which the test button was pressed.

During the test, the message "TEST" is shown in the status line. The message "TEST" flashes if the message currently displayed has caused the test.

The associated devices are tested one after another. TM800 automatically evaluates the currently occurring messages. Once the process is complete, either a common message about a successful test or an error message is displayed.

If more than one device has been tested, a separate error code will be displayed for each device failing the test. The following error codes are displayed in the event of an Isometer failing the test:

Error code	Meaning: for 107TD47 (medical Isometer)	Meaning: for IRDH... (industrial Isometer)	Note
0	No messages received from the ISOMETER <sup>®</sup> although the test command was confirmed by the ISOMETER <sup>®</sup> .	No messages received from the ISO-METER <sup>®</sup> although the test command was confirmed by the ISOMETER <sup>®</sup> .	
1	Only insulation fault message received.	Only insulation fault message from channel 1 received.	Channel 1

Error code	Meaning: for 107TD47 (medical Isometer)	Meaning: for IRDH... (industrial Isometer)	Note
2	Only overload message received.	Only insulation fault message from channel 2 received.	Channel 2
3	Only insulation fault message and overload message received.		Channel 1 and 2
4	Only overtemperature message received.		Channel 3
5	Only insulation fault message and overtemperature message received.		Channel 1 and 3
6	Only overload message and overtemperature message received.		Channel 2 and 3
14	Test command could not be sent because no query was made (slave).	Test command could not be sent because no query was made (slave).	Slave only
15	ISOMETER® did not confirm the test command (no answer).	ISOMETER® did not confirm the test command (no answer).	

#### Information on error codes

- For TM800 alarm indicator and operator panels, which are "slaves" on the BMS bus, a timeout of 50 seconds is applicable for error codes 0 and 14.
- Error code 14 occurs when a request for a test to be performed on a slave has been made, but the test command cannot be sent because the TM800 has not been queried. In this case, the master was not able to scan the TM800 because the address gap upstream of the TM800 was too large. This error code is not so much an indication of a faulty ISOMETER® but that the BMS bus system is faulty.





## 8. Menu mode: Operation and setting

### 8.1 Switching on and calling the main menu

When the TM800 is connected to the power supply, the following information appears on the display for approx. 3 seconds. Details about the address and the firmware version of the device are displayed. This information is also available in the "Info" menu.

```

TM800   Addr. : 01 / 001
Software 4.02   D279
Date:      02.05.12
Bender GmbH Grünberg
    
```



*If the TM800 was not connected to the power supply for several days, it may take some time until the starting procedure has completed (approx. 30 seconds). In this case, enter the time and date again.*

If there are no messages pending, the standard display will be shown when the starting procedure is completed.

```

*****
*** SYSTEM READY !**
Bender GmbH Grünberg
          09:50
    
```

The TMK-SET software allows you to change the standard display and the message texts.

Press the "Menu" button to open the main menu.

```

1. Exit
2. Values
3. History
4. Settings
    
```

The following buttons can be used in the main menu:

ESC	Exit function or go up one menu level
▲, ▼	Select menu items
↵	Confirm the selected menu item (Enter)



*The menu mode is exited automatically if no buttons are pressed in one of the menus for more than five minutes (exception: "Test communication" in the "Control" menu and "Position mode" in the "External devices" menu).*



Some menus are password-protected. Password protection is only effective if the password has been enabled (switched on).

When an attempt is made to open one of these menus, the password entry screen display appears automatically:



Once a valid password has been entered, full access will be given to all menus (except to the service menu) until menu mode is exited.

## 8.2 Menu overview diagram

The following diagram will help you to navigate through the menus:

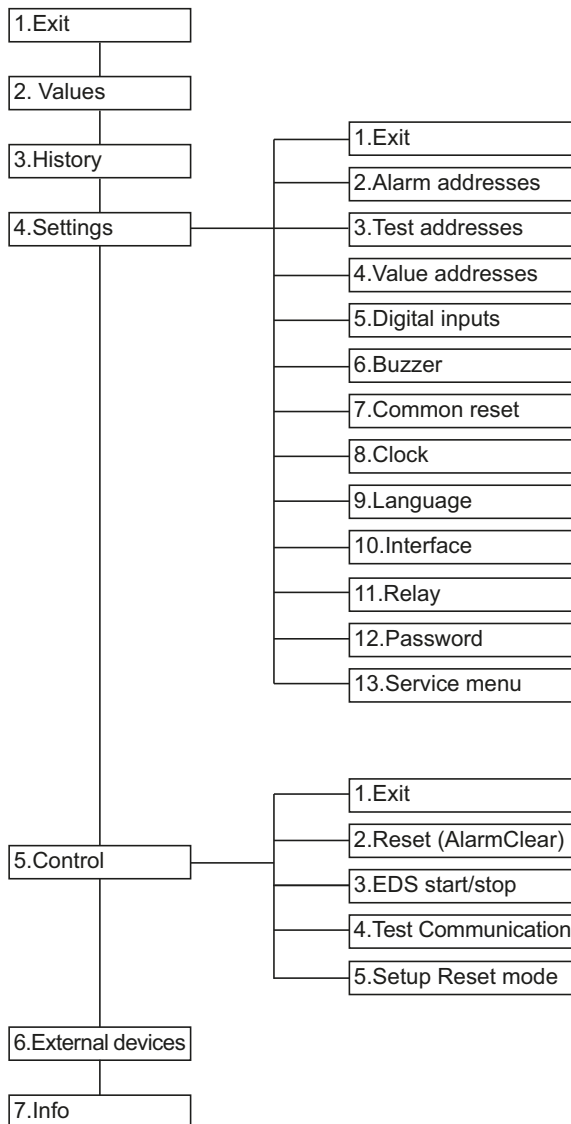

## 8.3 Main menu functions

Menu item	Function	Page
1. Exit	Exit menu mode	57
2. Values	No function	57
3. History	Displays history with information about messages, acknowledgements and associated times.	57
4. Settings	Various settings for this TM800	59
5. Control	This menu offers various options for controlling the overall system.	67
6. External devices	Settings on the connected evaluating devices (e.g. EDS4xx and RCMS4xx).	68
7. Info	Information about the device type, the firmware version and the last time the assignments were transmitted.	70

## 8.4 The main menu

### 8.4.1 Exit

Exits menu mode.

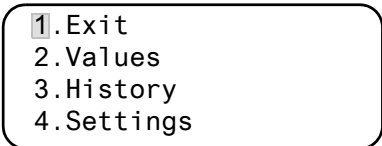

1.Exit  
2.Values  
3.History  
4.Settings

### 8.4.2 Menu2: Values

This menu has no function.

### 8.4.3 Menu 3: History

The TM800 can store up to 1000 messages in the history memory (ring buffer). If more than 1000 messages are stored by the TM800, message 1001 will overwrite message 1.

The "History" menu provides information about messages, acknowledgements and their time stamps. It also indicates whether an alarm is still pending or when it was acknowledged or muted with the "🔇" button. The complete content of the history memory with additional texts and address of the device sending the message can be displayed on a PC and printed out using the TMK-History software version 3.x or higher. Connection to the TM800 can be established via USB interface and the internal and or external BMS bus.

1. Use the arrow buttons to select the entry you require.  
The latest entry appears first on the display. Older messages can be selected using the arrow buttons.

```
Entry:      ⬆ 003/003
From: 04.12.11 16:00
Ack.: 04.12.11 16:00
to: 04.12.11 16:03
```

2. Press the "⌵" button to call up the message text of the selected entry. In the last line, the path the message took to reach the TM800 is displayed. In this case an insulation fault was received via the internal BMS bus from address 003, channel 01.  
The table on the following page contains information about other possible displays.

```
System:      01
Insulation fault
Meas. value: ⬆
Addr/Ch: 01/003/01
```

3. If analogue values are displayed, as shown in the example above, the maximum and minimum values can be displayed by pressing the "▲" button.
4. Press the "⌵" again to select an entry.

Repeat these operating steps for all messages you need. Then press "ESC" to exit the menu.  
Possible displays in the last line of the history memory message text display:

Text	Meaning
Address: ee/iii/kk	Address of the device triggering the message (ee = external BMS bus address, iii = internal BMS bus address, kk= channel no. of message).
Digital Inp No kk	Number (kk) of the digital input on this TM800 which triggered the message.
TESTex	Note that the current history entry was created as the result of a test triggered on this TM800.
TESTin	Note that the latest history entry was made due to a test initiated on the device assigned to it (insulation monitoring device, LIM, GFCI).

#### 8.4.4 Menu 4: Settings

The following menu items are available for configuring the TM800:

Menu item	Function	Page
1. Exit	Exit "Settings" menu; go up one menu level.	
2. Alarm addresses	Bus address setting for devices whose alarm messages are to be displayed on this TM800.	59
3. Test addresses	Setting bus addresses for devices which are required to carry out a test when the "TEST" button is pressed.	60
4. Value addresses	No function	61
5. Digital inputs	Setting of the operating behaviour for digital inputs.	61
6. Buzzer (and LED)	Setting of the frequency and repetition rate of buzzer signal.	63
7. Common reset	Setting whether this TM800 should respond to a common acknowledgement initiated via the reset button on a higher-level device.	63
8. Clock	Setting of the date and time on the real-time clock on this TM800. At the same time this setting is sent via BMS bus and all other devices are synchronised. The device with address 1 (TM... or MK...) synchronises all other devices every hour.	63
9. Language	Selection of the operating language for the TM800 (German or English).	64
10. Interface	Setting of the device address and baud rate for this TM800.	65
11. Relay	Operating mode and function of digital input 1 of the TM800	65
12. Password	Change password, activate/deactivate password.	66
13. Service menu	These settings can only be made by authorised Bender Service personnel. Retrieve information about the device status, enter settings for special operating conditions and execute a firmware update.	66

##### 8.4.4.1 Exit

Exit menu mode.

1. Exit
  2. Alarm addresses
  3. Test addresses
  4. Value addresses

##### 8.4.4.2 Settings menu 2: Alarm addresses

Bus address setting for devices whose alarm messages are to be displayed on this TM800. The text of individual messages can be modified using the TMK-SET software. Select the addresses of devices whose messages are to be displayed. Set addresses are monitored for presence on the BMS bus; if a device cannot be found on the bus, a corresponding message will appear.

If several systems or areas (e.g. several operating theatres) are connected to the TM800, the numbers 1...4 can be assigned to them.

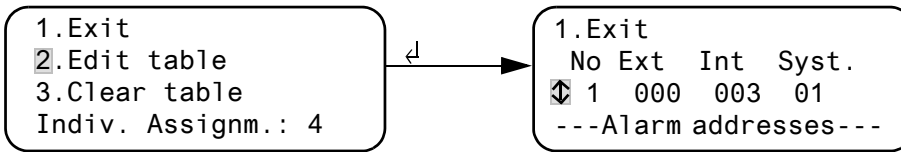

- 1. Exit                      Back to the main menu
- 2. Edit table              Use the arrow buttons to select the line "No" and confirm with the "↵" button. Use the arrow buttons to set the external BMS bus address "Ext" and confirm with the "↵" button. Use the arrow buttons to set the internal BMS bus address "Int" and confirm with the "↵" button. Use the arrow buttons to select the external system number "Syst." and confirm with the "↵" button. TM800 always adds a new line at the end of the table. This line can be modified (e.g. 4 000 000 00 off). In this way, other alarm addresses can be activated.
- 3. Clear table             Deactivate all addresses ("off"). "Clear table" is only possible when no test addresses are activated.

Possible settings for the system number "Syst.":

Syst.	Meaning
00	There's no text in line 1 of the alarm message.
01...04	Texts of "System 01" to "System 04" are displayed.
T	Programmed text is displayed.
Off	Deletes the current line of the table

**8.4.4.3 Settings menu 3: Test addresses**

Set the bus addresses for insulation monitoring devices (z. B. 107TD47, IRDH...), transfer switching devices with monitoring functions (ATICS®), LIM (Line Isolation Monitors) and GFCI (Ground Fault Circuit interrupters), which are required to carry out a test when the "TEST" button is pressed. The setting can only be made for devices which have also been activated in the "Alarm addresses" menu and/or programmed for individual alarm texts. Individual alarm texts are a minimum requirement for:

- Channel 1...3 (setting "107TD47")
- Channel 1 (setting "IRDHxxx")

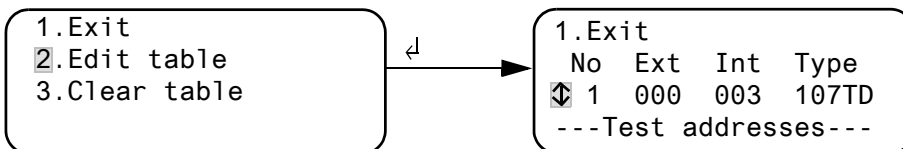

1. Exit Back to the main menu
2. Edit table Use the arrow buttons to select the line "No" and confirm with the "↵" button.  
Use the arrow buttons to set the external BMS bus address "Ext" and confirm with the "↵" button.  
Use the arrow buttons to set the internal BMS bus address "Int" and confirm with the "↵" button. Use the arrow buttons to select insulation monitoring device "Type" and confirm with the "↵" button.  
TM800 always adds a new line at the end of the table. This line can be modified (e.g. 4 000 000 off). In this way other test addresses can be activated.
3. Clear table Deactivate all addresses ("off").

Possible settings for "Type":

Syst.	Meaning
107TD	Insulation monitoring device, e. g. 107TD47
IRDHx	Industrial insulation monitoring device, e. g. IRDH...
GFCI	Ground Fault Circuit Interrupter
LIM	Line Isolation Monitor
Off	Deletes the current line of the table

#### 8.4.4.4 Settings menu 4: Measurement addresses

Currently has no function.

#### 8.4.4.5 Settings menu 5: Digital inputs

Setting of the operational characteristics of the digital inputs IN1...IN.. (TM800 in combination with BMI8/8 or BMI8/4 only). The following setting can be made individually for each input: "24V" (high) or "0V" (low). When the input is set to "24V" an alarm message will be sent when the voltage at the input is 24 V. When the input is set to "0V" an alarm message will be sent when the voltage is 0 V. It is for this reason that you should always set unused digital inputs to "off".

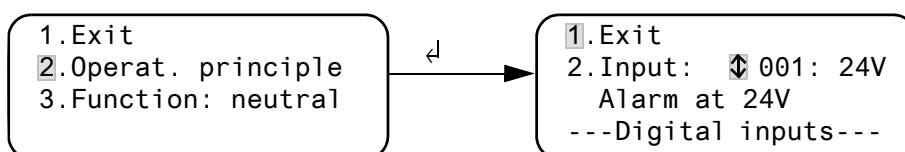

1. Exit Back to the main menu
2. Use the arrow buttons to select the operating mode for the digital input and confirm with the "↵" button,select "0 V", "24 V" or "Off" using the arrow buttons. Press "↵" to accept the entry. Repeat the procedure to set more digital inputs.
3. Function Set the message text category to "neutral" or "medical", see chapter "Alarm texts for the digital inputs" on page 62.



*Alarm messages for medical gases are signalled by the red "ALARM" LED and the buzzer sound. The buzzer can be set to mute. The buzzer sounds again every 12 minutes as a reminder.*

*Individual settings can only be made using the TMK-SET software.*

### Alarm texts for the digital inputs

To all digital inputs a neutral or specific alarm message can be assigned. A neutral alarm message indicates the alarm, the channel and the address of the device triggering the alarm. In comparison, a specific alarm message (medical) signals a fixed pre-programmed alarm, e.g. "oxygen". Assign the inputs according to the table "Neutral and specific alarm messages"

The TMK-SET PC software can be used to assign other messages to individual or all digital inputs.

The alarm messages in the following table are sent to other TM... or MK... panels via the BMS bus and displayed there in plain text format. If freely programmable alarm messages need to be displayed on a different TM... or MK..., the same alarm messages must have been programmed in the displaying device.

### Specific alarm messages

These messages contain details about medical gases and BSV systems. Alarm messages for medical gases are signalled by the red "ALARM" LED and the buzzer sound. The buzzer sound can be set to mute (acknowledged). The buzzer sounds again every 12 minutes as a reminder. Individual settings can only be made using the TMK-SET software.

### Neutral and specific alarm messages

Inputs	Neutral alarm messages "FuncNeutral"	Specific alarm messages "Function: Medical"	LED
IN1	Alarm: Address/channel XXX/01	Alarm: Oxygen	Alarm (red)
IN2	Alarm: Address/channel XXX/02	Alarm: Vacuum	
IN3	Alarm: Address/channel XXX/03	Alarm: Nitrous oxide	
IN4	Alarm: Address/channel XXX/04	Alarm: Compressed air 5 bar	
IN5	Alarm: Address/channel XXX/05	Alarm: Compressed air 8 bar	
IN6	Alarm: Address/channel XXX/06	Alarm: Nitrogen	
IN7	Alarm: Address/channel XXX/07	Alarm: CO2	
IN8	Alarm: Address/channel XXX/08	Alarm: BSV battery operation	Warning (yellow)
IN9	Alarm: Address/channel XXX/09	Alarm: BSV overload	
IN10	Alarm: Address/channel XXX/10	Alarm: BSV converter failure	
IN11	Alarm: Address/channel XXX/11	Alarm: BSV fault	
IN12	Alarm: Address/channel XXX/12	Alarm: BSV test run	
IN13	Alarm: Address/channel XXX/13	Alarm: BSV mains operation	
IN14	Alarm: Address/channel XXX/14	Alarm: Failure air conditioning	
IN15	Alarm: Address/channel XXX/15	Alarm: OP light battery operation	
IN16	Alarm: Address/channel XXX/16	Alarm: Sat OP light battery operation	



#### 8.4.4.6 Settings menu 6: Buzzer (and LED)

The buzzer will sound in the event of an alarm. Setting of the frequency and repetition rate of the two consecutive buzzer sounds.

```

1.Exit
2.Warning:      6
3.Alarm:       8
  
```

- |            |  |
|------------|--|
| 1. Exit    | Back to the main menu  |
| 2. Warning |  |
| 3. Alarm   | A variety of signals can be preset for "Warning" and "Alarm". An individual buzzer sound can be set via the TMK-SET software. During the setting procedure the selected buzzer signal sounds and the LED lights up or flashes. |

#### 8.4.4.7 Settings menu 7: Common reset

Set whether this TM800 should respond (on) or not (off) to the acknowledgement of the buzzer sound by pressing the "Buzzer off" button on an MK... or on another TM... panel

When common acknowledgement is switched on, the buzzer sound of this TM800 can also be acknowledged (muted) on an MK... or a TM... that is located in another room. The alarm message itself will remain visible on the display until its cause has been rectified.

```

1.Exit
2.C.Reset Int.: On
3.C.Reset Ext.: On
  
```

- |                  |   |
|------------------|---|
| 1. Exit          | Back to the main menu.  |
| 2. C.Reset Int:  | Setting for the internal BMS bus:<br>On Buzzer can be acknowledged externally.<br>Off Buzzer cannot be acknowledged externally. |
| 2. C.Reset Ext.: | Setting for the external BMS bus:<br>On Buzzer can be acknowledged externally.<br>Off Buzzer cannot be acknowledged externally. |

#### 8.4.4.8 Settings menu 8: Clock

This menu is used to set the time, date and date format display. These settings remain stored after a supply failure for approx. 5 days.

The clock adjusts itself automatically to the Central European Summer Time (CEST) and wintertime (CET). Adjust the time again if the time no longer corresponds to the local time after automatic switchover. The automatic switchover can be deactivated (menu item "5. Summertime").

```

1.Exit          (CET)
2.Time         11:45
3.Date        27.12.11
4.Format:     dd.mm.yy
  
```

- |           |                                      |
|-----------|--------------------------------------|
| 1. Exit   | Back to the main menu                |
| 2. Time   | Set the time (hours and minutes)     |
| 3. Date   | Set the date (DD.MM.YY)              |
| 4. Format | Select German or American (mm/dd/yy) |

5. Summer time            Setting to automatic switchover to central European summer time:  
                                  auto        automatic switchover  
                                  off         no switchover



*Time and date for the system can be set on any MK... or TM... panel. The settings are transferred via the BMS bus to the master device (address 1), which transfers the settings to all other MK...or TM...panels.*

**8.4.4.9 Settings menu 9: Language**

Selection of the language for the operation of the menu and the display of the messages (alarm and operating messages) for the TM800. Changes take effect immediately.

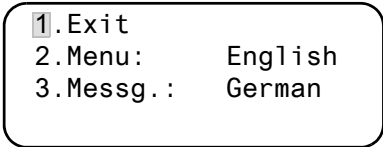

1. Exit                            Back to the main menu  
 2. Menu                         Set the operating language for the menu: German or English  
 3. Mess.                         Select the language for the message display. You may select:

German	English	French	Italian
Spanish	Portuguese	Portuguese (Brazil)	Dutch
Norwegian	Swedish	Finnish	Danish
Polish	Hungarian	Czech	Slovenian
Croatian	Serbian	Turkish	Indonesian
Russian			



*The language setting activates the language-specific characters. However, user-defined alarm texts remain unchanged. For this reason, you should only programme and transfer individual alarm texts after language selection.*

#### 8.4.4.10 Settings menu 10: Interface

Setting of the own device address and the transfer rate (baud rate) for the connection to the BMS bus.

```

1. Exit
2. Addr. ext.: 1
3. Baud ext.: 57600
4. Addr. int.: 1
    
```

- 1.Exit Back to the main menu.
- 2.Addr. external Setting of the external BMS bus address.  
Addresses between 1 and 99 may be selected, (factory setting: 1).  
"Off" = external Bus is switched off.
- 3.Baud external The baud rate of the external BMS bus is selectable: 19200, 38400 or 57600 bit/s, (factory setting 57600 bit/s. This setting can also be carried out when the external bus is switched off.
- 4.Addr. internal Setting of the internal BMS bus address.  
Addresses between 1 and 150\* may be selected, (factory setting: 1).  
This setting can only be changed when the external bus has been switched off before.  
On the internal BMS bus the baud rate is set to a fixed value of 9600 bits/s.

Change the corresponding device address if several TM800 are connected to one BMS bus. One TM800 must have the address 1 (master).

All other TM800 are addressed in consecutive order: 2, 3, 4... There should be no gaps between addresses. Only in this way the functionality of the system can be ensured (also refer to the "BMS bus" manual). Data exchange will only work between devices with the same baud rate.

\* The addresses 100...103 are intended for special tasks (e.g. programming) and therefore cannot be assigned.

#### 8.4.4.11 Settings menu 11: Relays

Set the relay mode and function for the optional digital input 1 of the TM800. Only TM800 panels with BMI8/8 or BMI8/4 offer this menu.

```

1. Exit
2. Operat. princ.: N/O
3. Mode:
   Device error
    
```

- 1. Exit Back to the main menu
- 2. Relay mode Set the mode of operation:  
N/O operation  
N/C operation
- 3. Function Output switches in the event of:

Setting	Description
Programmable	Programming via TMK-SET -> individual alarms or operating messages
Device error	Relay switches when an internal fault occurs on TM800
Common alarm	Relay switches in case of any warning or alarm message.

Setting	Description
Device failure	Relay switches as soon as the TM800 recognises a device failure
Test	Relay switches for approx. 1 seconds once a test has been started via the "TEST" button on the assigned devices (insulation monitoring devices, LIM, GFCI).
Buzzer	The relay switches as soon as the buzzer sounds. Also other signalling devices can be installed to indicate pending messages on the TM800.

#### 8.4.4.12 Settings menu 12: Password

Change, activate/deactivate password.

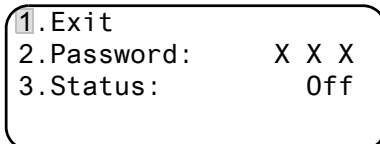

- 1. Exit                      Back to the main menu
- 2. Password                Change password. Factory setting: 807
- 3. Status:                  Activate or deactivate password protection.



*Some menus are password-protected. Password protection is only effective if the password has been enabled (switched on).*

*When an attempt is made to open one of these menus, the password entry screen display appears automatically:*

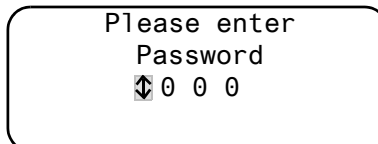

*Once a valid password has been entered, full access will be given to all menus (except the Service menu) until menu mode is exited.*

#### 8.4.4.13 Settings menu 13: Service menu

Only Bender service personnel are authorised to make settings in the Service menu. Access to this menu is possible only when the correct password is entered.

In the Service menu, information about the device status can be called up and settings for specific operating conditions can be made.

### 8.4.5 Menu 5: Control

This menu offers various options for controlling individual devices or the whole system:

Menu item	Function	Page
1. Exit	Exit "Control" menu; go up one menu level.	67
2. Reset (AlarmClear)	To reset all fault messages pending on the BMS bus.	67
3. EDS Start/Stop	Manual starting/stopping of test procedure on the EDS system	67
4. Test communication	Testing of communication via the BMS bus (TM800 with BMI8/8 resp. BMI8/4 only).	68
5. Reset mode	Determine whether a reset is to be carried out via the internal BMS bus only or also via the external BMS bus.	68

#### 8.4.5.1 Exit

Exit menu mode.

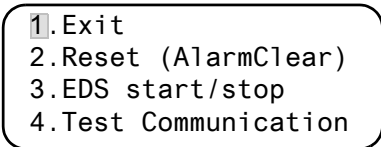

#### 8.4.5.2 Control menu 2: Reset (AlarmClear)

Press the "↵" button to reset fault messages pending on the BMS bus. "Reset done!" will then appear in the last line.

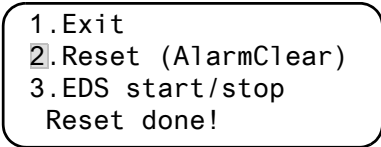

This reset command is sent via the BMS bus. Note that some devices (e.g. PRC487) do not respond to this reset.

#### 8.4.5.3 Control menu 3: EDS Start/Stop

Press the "↵" button to start and stop the measuring procedure of the EDS system. This function can only be activated by the master. The current status appears in the last line.

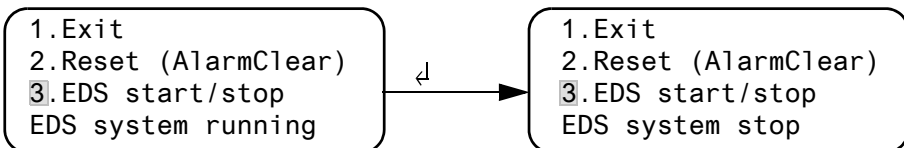

EDS system running      Once started, EDS4xx-12 and PGH47x run continuously. If you exit the menu, "EDSp" will appear in the last line of the standard display in order to indicate continuous running\*.

EDS system stop      Stops the EDS4xx-12 and PGH47x from continuous operation. If you exit the menu, "EDS" will appear in the last line of the standard display until the current measurement cycle finishes.

\* Other abbreviations that might appear in the last line of the display:

EDSa                    Automatic mode: Insulation fault location has been started by e.g.

ISOMETER®, ATICS® or isoMED427P on PGH47x.

EDSs                    Single mode A single run has been started by IN2 on PGH471.

**8.4.5.4 Control menu 4: Test communication**

Testing the communication via the BMS bus. For this purpose, an error message is simulated on a digital input. This fault message is sent to evaluating devices (such as MK..., TM..., SMO...) via the BMS bus. Check that these devices are responding to the fault message as requested.

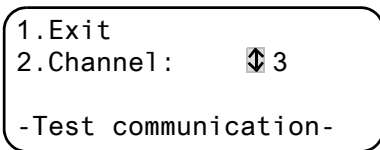

Channel 3              Setting of the channel whose message is to be activated.

**8.4.5.5 Control menu Reset mode**

Set whether the reset command should have an effect on the internal BMS bus only or also on the external bus. Setting possibilities

- internally only
- internally and externally

**8.4.6 Menu 6: External devices**

This menu is used to set and control external devices. Functions include for example displaying information about connected devices (address, software version, device type) or continuous displaying a channel on a connected evaluator.

Select the BMS bus to which the external device is connected.

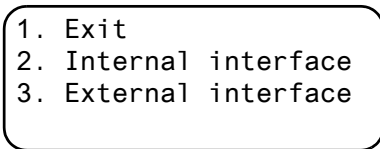

Internal interface      Devices connected to the internal bus of this TM800 can be displayed and adjusted.

External interface      Devices connected to the external bus of this TM800 can be displayed and adjusted. If other Bender devices utilising an internal bus (TM..., MK...) are addressed via the external bus, also the devices connected to this internal bus can be displayed and adjusted.

Devices which can be parameterised:

EDS46x, EDS47x, EDS49x,

RCMS460, RCMS470, RCMS490

The device connected to the selected bus will be displayed. Select the address of the external device to be displayed (e.g. EDS4xx-12 or RCMS4xx-12).

```
1. Exit (internal!)
001: TM800 V4.04
002: EDS470 V3.20
003: 107TD47 V2.52
```

Address, type and version of the connected device are displayed. When no device is detected under this address, the character "?" appears.

Use the arrow buttons to select the address of the external device and confirm your selection with the "↵" button.

If the device has been recognised, the TM800 will read the current settings of the connected device. In the first line of the display shows the device type.

Use the Up/Down buttons to select the appropriate function or device setting and confirm with the "↵" button. Example:

```
1. Exit (107TD47)
2. Position mode
```

```
1. Exit (107TD47)
2. Channel ↕ 1
   Re= 20 KΩ
```

in the EDS or RCMS menu there are a number of setting possibilities. These are described in more detail in the operating manuals for the corresponding systems.

```
1. Exit (EDS470)
2. General
3. Channel
4. Relay
```

### 8.4.7 Menu 7: Info

```

TM800   Addr. : 01/001
Software 4.02   D279
Date: 02.09.12
www.bender.de
    
```

Information about the device type, the firmware version and the last time assignments were transmitted. Assignments are settings carried out via PC software (e.g. TMK-SET):

- Enter standard texts
- Assigning texts and functions to the alarm messages and digital inputs of the TM800
- Set parameters

Select:

ESC                      Exit menu mode

▲                         Show date of last assignment transmission:

```

Assignments
programmed
on: 12.07.13   07:07
    
```

▼ (press once)         Show version of standard texts and version of the boot loader (internal software for updates). Number of BI800S and BMIx/x.

```

Text version:      2.20
Bootloader         2.20
Number of BI800    0
Number of BMI X/X  0
    
```

▼ (press twice)        The alarm addresses, test addresses and individual messages and the number of the devices will be displayed. Switching commands: (TM800 with BMI8/4 resp. BMI0/4 only).

```

Alarm addresses    0
Test addresses     0
Indiv. Assignm.   0
Switch.cmd. T/D: 00/00
    
```

↵                        Go back to the main menu



## 8.5 Overview of setting options

The TM800 provides various setting possibilities. The table below shows where the individual parameters can be set.

Parameter Name	Range	Factory setting	User setting	Adjustable via		TMkset Parameter menu	Note
				TM800/MK800 Menu no.	TM800/MK800 Service menu item		
Buzzer settings	(0).1..9	6		4.6.2	--	Buzzer settings	Frequency setting 1..2, buzzer interval for ALARM and WARNING, selection of predefined messages (preset)
Warning Alarm	(0).1..9	8		4.6.3	--		
Common reset	y/n	y		4.7.2	--	Buzzer mute via bus	Setting whether an external device should respond to an alarm acknowledgement to mute the buzzer on the int. (ext.) BMS
Int. Ext.	y/n	y		4.7.3	--	RS-485 int. RS-485 ext.	
Clock/date	dd.mm.yy / mm/dd/yy	dd.mm.yy auto		4.8.4	--	Clock /Date/ CEST automatic	Set the time and date / automat. summertime/wintertime on/off
Summertime	auto/off	auto		4.8.5	--		
Language	Deutsch/English	Deutsch	Deutsch	4.9.2	--	Language	Menu language setting
Message Interface	20 languages	Deutsch	Deutsch	4.9.3	--		
Addr. external	1..99/off	1		4.10.2	--	RS-485 settings external address	Switch off unused external interface Ext. BMS off for single panels: faster internal communication.
Baud external	19800..57600	57600		4.10.3	--	external baud rate	In case of communication problems, reduce the baud rate.
Addr. internal	1..150/off	1		4.10.4	--	internal address	Int. BMS off for parallel panel: faster external communication. Internal address can only be set when the ext. BMS is switched off.
Digital output 1	Function			4.11	--	Digital output 1	Setting of the function for the first digital output or relay: Test/device error/common alarm/device failure/programmable
Operating mode	Operating mode				--		
Password prompt	X X X	807		4.12.2	--	Password required	Changing the password
Password Status	on/off	on		4.12.3	--		Activating/deactivating the password prompt
Reset mode	int./int.+ext.	int.		5.5	--	Reset mode *)	Determine the effect of the RESET command (for devices with fault memory: EDS, RCMS, ISOMETER) via BMS
History buffer	--	--	--	--	--	Diagnostic information	Display the number of available data records.
History memory reset	--	--	--	--	--	History memory reset	Clear all data records in the history memory.
Reset counter	--	--	--	--	--	Reset counter	Display the Power-Down, Watchdog and external reset counters
Reset all reset counters	--	--	--	--	--	Reset all reset counters	Reset all reset counters
Indication of the digital input states and tasks	--	--	--	--	--	--	Indication of the digital input states and tasks
Test of individual outputs: set the output number	--	--	--	--	--	--	a) Test of individual outputs: set the output number
Display the buttons that are pressed	--	--	--	--	--	--	b) Display the buttons that are pressed
Timeout on int. BMS: 060 ms	--	--	--	--	--	Timeout	Timeout on int. BMS: 060 ms
Timeout on ext. BMS: 010 ms at 56 kBd	42 ms...200 ms	60 ms		--	--	Timeout RS485 int.*/ RS485 ext.')	Timeout on ext. BMS: 010 ms at 56 kBd
May only be changed for test purposes!	10 ms...100 ms	10 ms		--	--		May only be changed for test purposes!
Display the stack load in %	--	--	--	--	--		Display the stack load in %
(R: Program stack; C: Data stack)	--	--	--	--	--		(R: Program stack; C: Data stack)
Indication (and reset) of the max. response times with the associated address on the int. and ext. bus	--	--	--	--	--	Timing Analysis 1	Indication (and reset) of the max. response times with the associated address on the int. and ext. bus
						7.2 Reset values	

Parameter Name	Adjustable via TM800/MK800		User setting	Factory setting	Range	TM800/MK800 Service menu item	TMKset Parameter menu	Note
	Menu no.	TM800/MK800						
MaxSlaveTime	--	8. Timing Analysis 2 8.2. MaxSlaveTime		3000 ms	500..3000 ms		MaxSlaveTime RS485 ext.*	a) Indication (and setting) of the MaxSlaveTime (3000 ms) When the time is exceeded, preference is given to the ext. interface b) Indication of the SlaveTimeExt (ms) c) Indication of the M.Delay Ext (ms)
Backlight Display Time	--	9. Backlight/Dis.Time 9.2 Backlight 9.3 Display Time	autom on	autom on	autom / alw.on on/off		LCD Backlight Show date/time*)	Background lighting automatically switched on when operated or in the event of an alarm or continuously switched on. Deactivate time display in the standard display.
Max-Address Gap	--	10. Addr.Gap/FaultCnt 10.2 Max-Address Gap	3	3	1..9		Max-Address Gap RS485 ext.*	Number of passes on the ext. bus until the failure message is created.
Max.Fault Count	--	10.3 Max. Fault Count 10.4 Addr.	3	3	0..9		Max.Fault Count Device failure alarm*)	Max. permissible number of missing answers until a failure message is generated. Affects the int. and ext. BMS. When the setting < 3 is selected, the int. BMS is set to 3. Display of the failure counter for an address on the int. BMS: „-“; no failure, „0“: failure message already activated.
Buzzer Buzzer-Type	--	11. Buzzer On/Off/Type 11.2 Buzzer On/Off 11.3 Buzzer-Type	On AC	On AC	On/Off for 1..9 h AC / DC		Buzzer On/Off*) Buzzer type*)	e.g. for the time of commissioning, the buzzer can be switched off for 1..9 h. Setting of the buzzer type : AC for int. Piezo / DC
Settings Ext. Bus	--	12. Settings Ext. Bus 12.2 D.....	1	1	0/1		Send state change of dig. inputs via ext. bus*)	Deactivating the forwarding of operating messages - of the digital inputs 1-16 to the external bus (e.g. for flashing messages) - of all EDS/RCMS devices on the int. BMS
Settings Int. Bus ALMI Idle-Time MaxVariation	--	13. Settings Int. Bus 13.2 ALMI Idle-Time 13.3 MaxVariation	2 s 25 %	2 s 25 %	1 s / 2 s 0..50 %		ALMI Idle-Time RS485 int.* MaxVariation*)	Time between 2 ALMI queries on the internal BMS. If the value on the int. BMS exceeds the MaxVariation, the value will be sent again via the ext. BMS. Shall test and service messages from ATICS channel 6 be indicated?
ATICS Maintenance	--	13.4 ATICS Mainten.	Off	Off	On / Off		Show ATICS service notes*)	
Time/Message	--	14. Time/Message 14.2 Time	3 s	3 s	3..8 s		Interval for messages	Time interval at which messages are displayed alternately, if different messages occur simultaneously. Display of the operating, alarm and failure messages currently pending.
Factory Setting	--	15. Factory Setting 15.2. Reset Parameter 15.3. Reset all	--	--	--			Reset of the memory content: - Only reset internal parameters. - In addition reset all tables, switching commands, texts (that means, reset to delivery state). Manual firmware update (only required, if a fault occurs during program-controlled updates)
	--	16. Firmware-Update	--	--	--		--	

\*) TMK-SET: only visible in the "Expert Mode"

## 9. Technical data

### 9.1 Technical data BM800/BM400 modules

#### Insulation coordination according to IEC 60664-1

Rated insulation voltage.....	AC 250 V
Rated impulse voltage/pollution degree .....	4 kV/3
Voltage supply TM800 .....	via integrated power supply unit, data depending on the type

#### BM800 module

Supply voltage $U_s$ .....	AC/DC 24 V
Frequency range $U_s$ .....	AC 40 . . . 60 Hz/DC
Operating range $U_s$ .....	AC 18 . . . 28/DC 19 . . . 30 V
The length of time the device can function in the event of a power failure: time, date.....	> 5 days
Restart in the event of voltage failure for at least.....	1.5 s
Display, characters.....	four lines, 4 x 20 characters
Standard message texts in .....	21 national languages
Alarm addresses .....	≤ 250
Text messages, programmable.....	1000
History memory (messages).....	1000
Standard text message.....	3 x 20 characters
Additional text message (press button to access) .....	3 x 20 characters
Alarm LEDs (three different colours) green (normal), yellow (warning), red (alarm)	
Menu texts.....	German/English
Buttons.....	5 (lamp test + test of assigned devices, buzzer mute, additional text, scroll, menu)
Power consumption .....	≤ 5 VA

#### Buzzer

Buzzer message.....	can be acknowledged, adoption of characteristics of new value
Buzzer interval .....	configurable
Buzzer frequency .....	configurable
Buzzer repetition	configurable

#### Interface internal/external

Interface/protocol.....	1 x RS-485/BMS internal, 1 x RS-485/BMS external
Baud rate.....	9.6 kbit/s internal, 19200 . . . 57600 kbit/s external
Cable length .....	≤ 1200 m
Cable: twisted pair, one end of shield connected to PE: J-Y(St)Y min. 2x0.8	
Terminating resistor .....	120 Ω (0.25 W) can be connected via DIP switch, factory setting: "off" position
Device address, BMS bus external/internal .....	1 . . . 150/1 . . . 99
Factory setting device address internal/external .....	1 (master)/1 (master)

#### Programming

Interfaces .....	RS-485 or USB (V2.0/V1.1), USB cable: Type A plug on Type B plug
Software.....	TMK-SET version 4.x or higher
Factory setting password query.....	activated

**Operating and display modules and I/O modules**

Operating and display modules BI800S:

Max. number of illuminated pushbuttons .....	80
Buttons/alarm LEDs per panel .....	5
Power consumption .....	≤ 2 VA

I/O module:

Maximum number of inputs and outputs .....	192/192
--	---------

**Environment/EMC**

EMC .....	EN 61326-1
-----------	------------

Ambient temperatures:

Operating temperature .....	-5...+55 °C
Transport .....	-25...+70 °C
Long-term storage .....	-25...+55 °C

Classification of climatic conditions acc. to IEC 60721:

Stationary use (IEC 60721-3-3) .....	3K5 (no condensation, no formation of ice)
Transport (IEC 60721-3-2) .....	2K3
Long-term storage (IEC 60721-3-1) .....	1K4

Classification of mechanical conditions acc. to IEC 60721:

Stationary use (IEC 60721-3-3) .....	3M4
Transport (IEC 60721-3-2) .....	2M2
Long-term storage (IEC 60721-3-1) .....	1M3

Option "W" data different from the standard version:

Classification of climatic conditions acc. to IEC 60721:

Stationary use (IEC 60721-3-3) .....	3K5 (condensation and formation of ice is possible)
--------------------------------------	---

Classification of mechanical conditions acc. to IEC 60721:

Stationary use (IEC 60721-3-3) .....	3M7
--------------------------------------	-----

**Connection properties (supply voltage, BMS bus):**

Rigid/flexible/conductor sizes .....	0.2...2.5/0.2...2.5 mm <sup>2</sup> /AWG 24...-12
Flexible with ferrules, without/with plastic sleeve .....	0.25...2.5/0.25...2.5 mm <sup>2</sup>

**Connection properties (inputs):**

Rigid/flexible/conductor sizes .....	0.08...1.5/0.08...1.5 mm <sup>2</sup> /AWG 28-16
Flexible with ferrules, without/with plastic sleeve .....	0.25...1.5/0.25...0.5 mm <sup>2</sup>
Stripping length .....	7 mm
Tightening torque .....	0.5...0.6 Nm

**Other**

Operating mode .....	continuous operation
Mounting .....	display-oriented
Connection .....	plug-in terminals
Degree of protection, built-in components (DIN EN 60529) .....	IP50
Degree of protection, terminals (DIN EN 60529) .....	IP20
Flammability class .....	UL94V-0
Weight .....	according to the respective version

**9.1.1 Standards, approvals and certifications**

The TM800 remote alarm indicator and operator panels comply with the requirements of IEC 60364-7-710, DIN VDE 0100-710.



## 9.2 Dimensions

### Flush-mounting enclosure with internal mounting frame, aluminium, silver matt anodised

Type	Design	Frame outer dimensions (W x H)/mm	Outside dimensions of the enclosure (W x H)/mm	Dimensions of the wall cutout (W x H)/mm
UPE-1	Tiles	297 x 297	307 x 307	310 x 310
UPE-2	Tiles	447 x 297	457 x 307	460 x 310
UPE-3	Tiles	297 x 447	307 x 457	310 x 460
UPE-4	Tiles	447 x 447	457 x 457	460 x 460
UPE-5	Tiles	447 x 597	457 x 607	460 x 610
UPE-6	Tiles	597 x 447	607 x 457	610 x 460
UPE-7	Tiles	597 x 597	607 x 607	610 x 610
UPE-8	Tiles	597 x 747	607 x 757	610 x 760

The dimensions refer to a tile grid of 150 mm.  
The enclosure has a wall thickness of 4 mm.

### Flush-mounting enclosure with bezel frame, aluminium, silver matt anodised

Type	Outer dimensions of the bezel frame (W x H)/mm	Outside dimensions of the enclosure (W x H)/mm	Outside dimensions of the wall cutout (W x H)/mm
UPB-1	333 x 333	307 x 307	310 x 310
UPB-2	483 x 333	457 x 307	460 x 310
UPB-3	333 x 483	307 x 457	310 x 460
UPB-4	483 x 483	457 x 457	460 x 460
UPB-5	483 x 633	457 x 607	460 x 610
UPB-6	633 x 483	607 x 457	610 x 460
UPB-7	633 x 633	607 x 607	610 x 610
UPB-8	633 x 783	607 x 757	610 x 760

The enclosure consists of a 4 mm wall thickness.

**9.2.1 Surface-mounting enclosure, aluminium, silver matt anodised**

Type	Dimensions (W x H x D)/mm
APK-1	300 x 300 x 150
APK-2	450 x 300 x 150
APK-3	300 x 450 x 150
APK-4	450 x 450 x 150
APK-5	650 x 450 x 150
APK-6	450 x 600x 150
APK-7	600 x 600 x 150
APK-8	600 x 750 x 150

**9.3 Ordering details**

Description	Art. No.
USB cable PC -> Alarm indicator and operator panel (Type A - Type B)	--
Parameterisation software: - TMK-SET V 4.0 parameterisation software for MK2430, MK800, TM800, - TMK-History V 3.x for MK2430, MK800, TM800, TM1000 and PRC1470 - USB driver software for MK2430, MK800 and TM800 - MEDISET V1.x parameterisation software for TM1000 and PRC1470	as Internet download
Suction cup d=80 mm	102850
Suction cup d=55 mm	102851

## 10. Internal components and modules

### Connection via I<sup>2</sup>C bus

Communication between the BM800/BM400 and different modules can be established by means of the I<sup>2</sup>C bus.



**CAUTION**

*Assign the addresses in consecutive order. The system can only function reliably when there are no gaps between the individual addresses.*



**WARNING**

*Use the module's inputs and outputs for its intended purpose only. It this is not taken into consideration the module and/or any component connected to it may be damaged.*

*Example: Never connect open collector outputs or digital inputs to the mains voltage! Risk of destruction!*

### 10.1 BM800 and BM400 module

#### 10.1.1 BM800 and BM400 dimensions

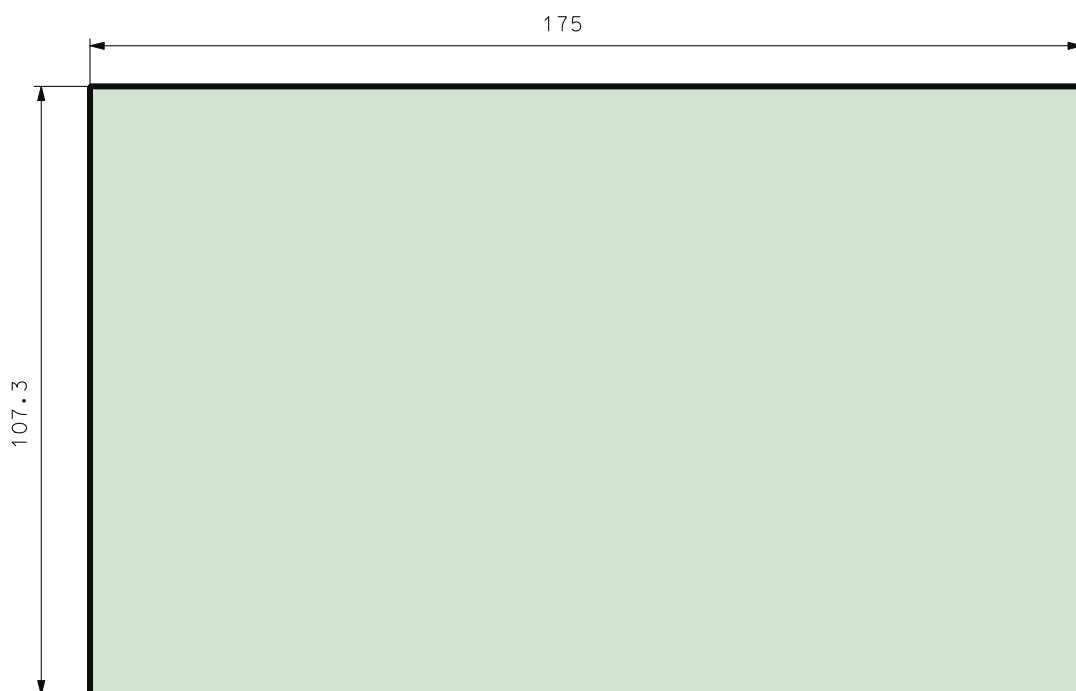

## 10.2 Operating and display module BI800S

The operating and display module BI800S is used to extend BM800/BM400 modules by 5 pushbuttons each. Per module, 16 operating and display modules (hence 80 individual pushbuttons) can be controlled via the I<sup>2</sup>C bus. An individual function (switch, pushbutton, LED etc.) can be assigned to each element of a BI800S operating and display module via PC software. The link between the element and the appropriate input, output or interface is also carried out via the PC software. In addition, acoustical messages can be set to be distinguishable from one another. In case of subsequent modifications of the functions, the hardware need not to be changed.

### 10.2.1 BI800S dimensions

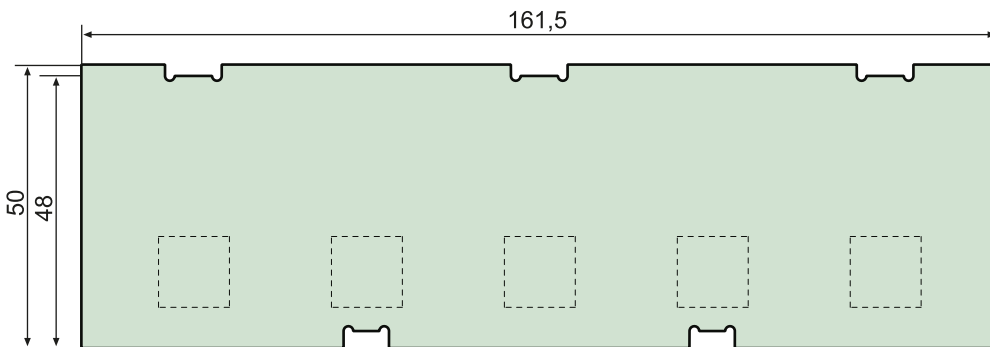

### 10.2.2 Wiring diagram BI800S

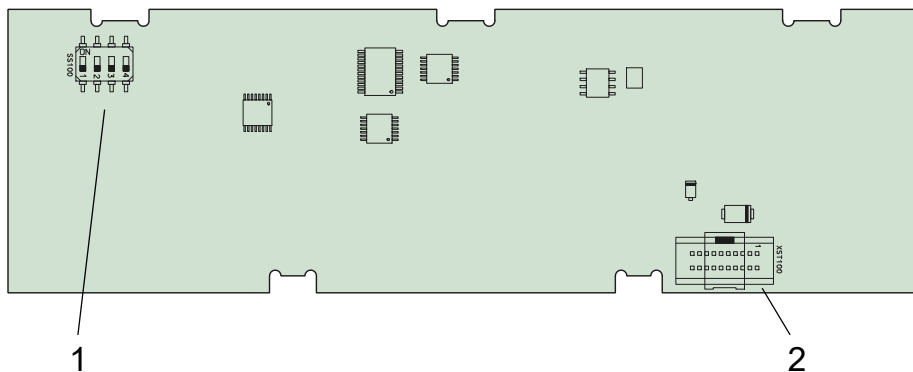

1SS100

DIP switch for setting the address on the I<sup>2</sup>C bus. The addresses 0...15 (7) can be set, see p.c.b. labelling.

2XST100

Connector I<sup>2</sup>C bus for connecting additional BI800S and connection to the display module.

### 10.2.3 Technical data BI800S

Buttons/alarm LEDs per panel

Power consumption ..... ≤ 2 VA

Address range..... 0...15



#### 10.2.4 Ordering information BI800S

Type	Description	Art. No.
BI800S	Operating and display module SMDLED for MEDICS® panels, 5 illuminated push-buttons, new version with SMD LEDs	B95100128

### 10.3 Operating and display module BI71S

BI71S includes five illuminated pushbuttons and five potential-free changeover contacts. The operating and display modules BI71S do not feature an I<sup>2</sup>C bus connection to the panel's p.c.b. BM800/BM400.

Application example: Direct control of remote-control switches for room lighting. Each LED can be individually controlled with 24 V. Diode decoupling for LED testing.

#### 10.3.1 BI71S dimensions

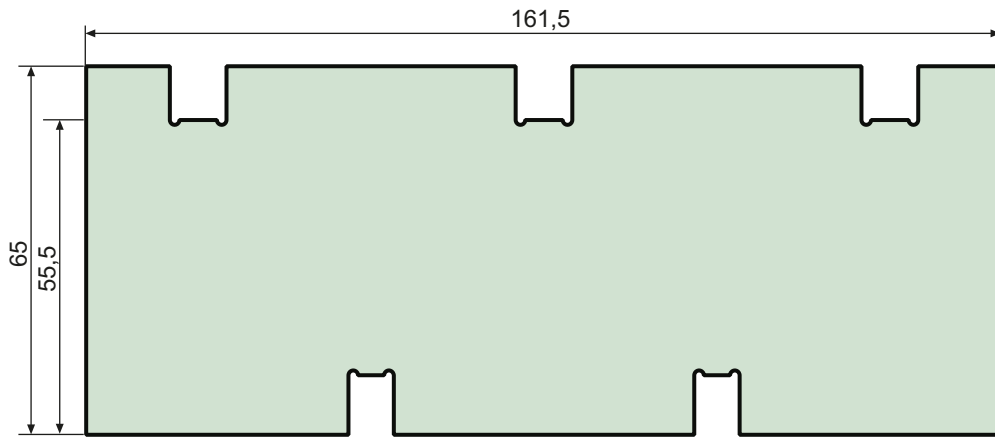

#### 10.3.2 Wiring diagram BI71S

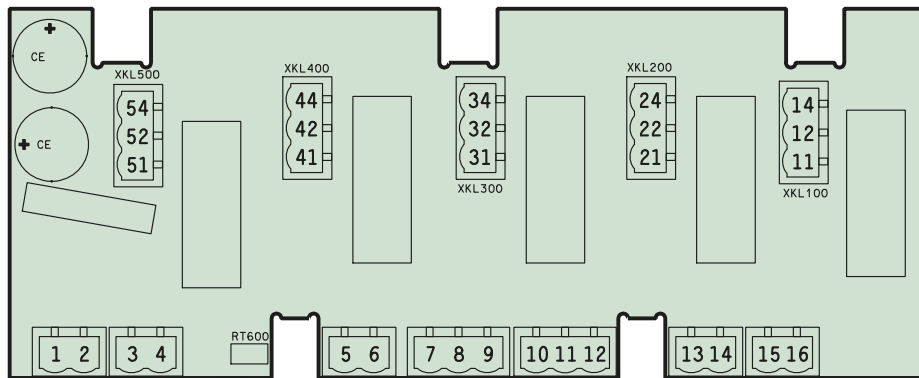

## Connections:

1	$U_5$ : DC +24 V or AC 24 V 50/60 Hz	13	LED 2, GND
2	$U_5$ : DC 0 V or AC 24 V 50/60 Hz	14	LED 2, +
3	Lamp test	15	LED 1, GND
4	Lamp test	16	LED 1, +
5	Output: GND		
6	Output: DC +24 V		
7	LED 5, GND	11, 12, 14	changeover contact K1
8	LED 5, +	21, 22, 24	changeover contact K2
9	LED 4, GND	31, 32, 34	changeover contact K3
10	LED 4, +	41, 42, 44	changeover contact K4
11	LED 3, GND	51, 52, 54	changeover contact K5
12	LED 3, +		

**10.3.3 Technical data BI71S**

Overvoltage category .....	III
Pollution degree .....	2
Rated insulation voltage.....	250V
Safe separation between the connections.....(1...16), (11...14), (21...24), (31...34), (41...44), (51...54)	
Voltage test according to IEC 61010-1 (basic insulation/protective separation) .....	2.21 kV/3.51 kV

## Supply:

Nominal voltage .....	DC 24 V, AC 24 V
Maximum current consumption .....	110mA

## Relay contacts:

Maximum current.....	8 A at AC 250 V/8 A at DC 24 V
Maximum switching load .....	AC 2000 VA/DC 192 W
Maximum switching voltage	
Minimum switching load.....	10 mA at DC 5 V

EMC .....	IEC 61000-6-2, IEC 61000-6-3
Operating temperature .....	-25 °C ... +55 °C

**10.3.4 Ordering information BI71S**

Type	Description	Art. No.
BI71S	Operating and display module with five illuminated pushbuttons, UC 24 V, for TM panels, new version with SMD LEDs	B92024071

## 10.4 Operating and display module BI72S

BI72S modules include five illuminated pushbuttons and five potential-free changeover contacts max. DC 30 V/2 A. The operating and display modules BI72S do not feature an I<sup>2</sup>C bus connection to the BM800/BM400 module.

Application example: Direct activation of remote-control switches for room lighting. Each LED can individually be controlled with 24 V. LED testing with all-pole switching via changeover relays on the internal supply voltage.

### 10.4.1 BI72S dimensions

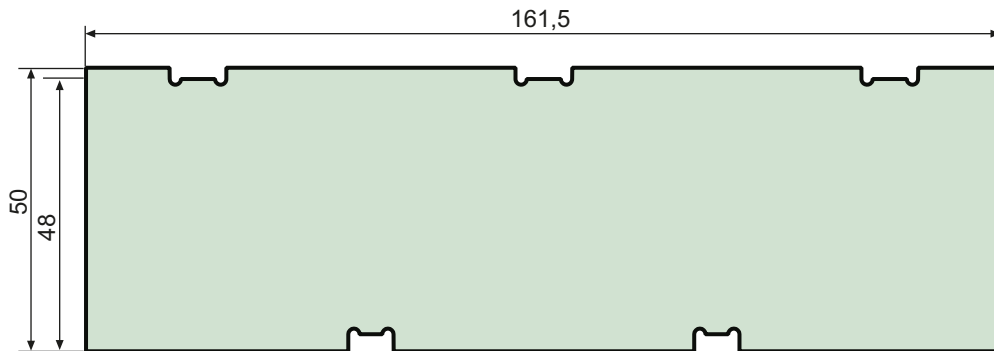

### 10.4.2 Wiring diagram BI72S

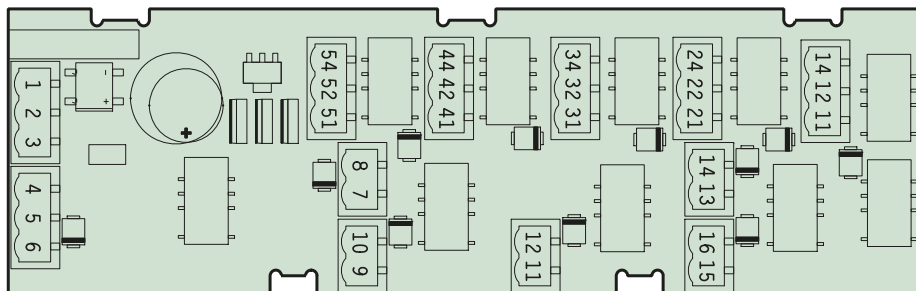

Connections:

1	$U_S$ : DC +24 V or AC 24 V 50/60 Hz	13	LED 2, GND
2	$U_S$ : DC 0 V or AC 24 V 50/60 Hz	14	LED 2, +
3	Lamp test	15	LED 1, GND
4	Lamp test	16	LED 1, +
5	Output: GND		
6	Output: DC +24 V		
7	LED 5, GND	11, 12, 14	changeover contact K1
8	LED 5, +	21, 22, 24	changeover contact K2
9	LED 4, GND	31, 32, 34	changeover contact K3
10	LED 4, +	41, 42, 44	changeover contact K4
11	LED 3, GND	51, 52, 54	changeover contact K5
12	LED 3, +		

### 10.4.3 Technical data BI72S

Supply:

Nominal voltage .....DC 24 V, AC 24 V

Maximum current consumption ..... 110mA

Relay contacts:

Maximum current ..... 2A

Maximum switching voltage ..... DC 30V

EMC ..... IEC 61000-6-2, IEC 61000-6-3

Operating temperature ..... -25 . . . +55 °C

### 10.4.4 Ordering information BI72S

Type	Description	Art. No.
BI72S	Operating and display module SMDLED with five illuminated pushbuttons, AC/DC 24 V, for TM panels, new version with SMD LEDs, contact voltage AC/DC 24 V	B92024072

### 10.5 I/O module BMI8/8

The I/O module BMI8/8 features 8 digital inputs and 8 open collector outputs. The open collector outputs are capable of driving a load of up to 15 W at an operating voltage of 24 V. They feature flyback diodes so that the relay can be directly connected.

#### 10.5.1 BMI8/8 dimensions

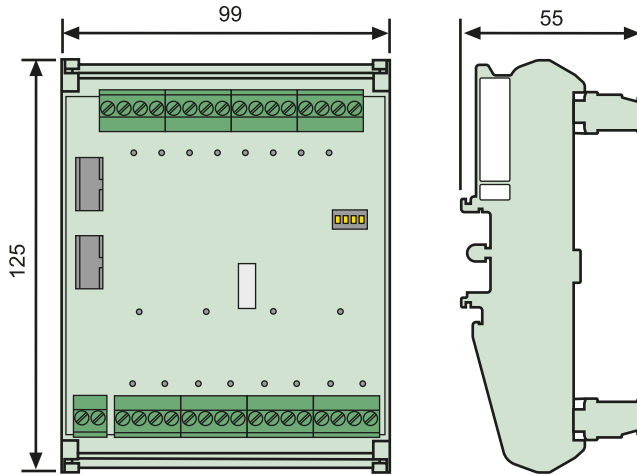

#### 10.5.2 Wiring diagram BMI8/8

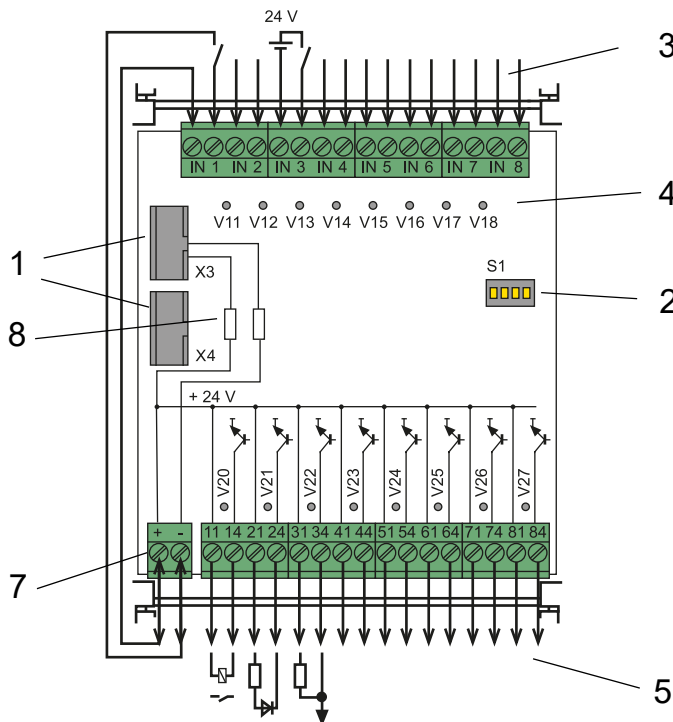

**Legend to wiring diagram BMI8/8**

1	X3, X4	Connector I <sup>2</sup> C bus for connecting additional I/O modules and connection to the display module.																				
2	S1	DIP switch for setting the address on the I <sup>2</sup> C bus by means of the bridge SJ (address 0 ... 15 = SJ open, address 16 ... 23 = SJ closed)																				
3	IN1 ... 8	Digital inputs 1...8 The digital inputs are controlled by voltage signals. These can be created by an internal or external voltage and potential-free contacts.																				
4	V11...V18	Alarm LEDs, light up when voltage is present at the associated digital input.																				
		<table border="0"> <tr> <td>Input</td> <td>Alarm LED</td> <td>Input</td> <td>Alarm LED</td> </tr> <tr> <td>IN1</td> <td>V11</td> <td>IN5</td> <td>V15</td> </tr> <tr> <td>IN2</td> <td>V12</td> <td>IN6</td> <td>V16</td> </tr> <tr> <td>IN3</td> <td>V13</td> <td>IN7</td> <td>V17</td> </tr> <tr> <td>IN4</td> <td>V14</td> <td>IN8</td> <td>V18</td> </tr> </table>	Input	Alarm LED	Input	Alarm LED	IN1	V11	IN5	V15	IN2	V12	IN6	V16	IN3	V13	IN7	V17	IN4	V14	IN8	V18
Input	Alarm LED	Input	Alarm LED																			
IN1	V11	IN5	V15																			
IN2	V12	IN6	V16																			
IN3	V13	IN7	V17																			
IN4	V14	IN8	V18																			
5	11...84	Open collector outputs, to control LEDs, relays etc.																				
6	V20...V27	Alarm LED, lights up when the associated open collector output is closed.																				
		<table border="0"> <tr> <td>Output</td> <td>Alarm LED</td> <td>Output</td> <td>Alarm LED</td> </tr> <tr> <td>11, 14</td> <td>V20</td> <td>51, 54</td> <td>V24</td> </tr> <tr> <td>21, 24</td> <td>V21</td> <td>61, 64</td> <td>V25</td> </tr> <tr> <td>31, 34</td> <td>V22</td> <td>71, 74</td> <td>V26</td> </tr> <tr> <td>41, 44</td> <td>V23</td> <td>81, 84</td> <td>V27</td> </tr> </table>	Output	Alarm LED	Output	Alarm LED	11, 14	V20	51, 54	V24	21, 24	V21	61, 64	V25	31, 34	V22	71, 74	V26	41, 44	V23	81, 84	V27
Output	Alarm LED	Output	Alarm LED																			
11, 14	V20	51, 54	V24																			
21, 24	V21	61, 64	V25																			
31, 34	V22	71, 74	V26																			
41, 44	V23	81, 84	V27																			
7	A1, A2	Supply voltage $U_S$ DC																				
8	R42, R59	Remove the zero- $\Omega$ resistance if external $U_S$ is applied.																				

**10.5.3 Technical data BMI8/8****Supply voltage**

Supply voltage $U_S$ .....	DC 24 V
Operating range $U_S$ .....	DC 18 ... 30 V

**Inputs**

Digital inputs	
Galvanic separation .....	yes
Control of digital inputs .....	via potential-free contacts/extraneous voltage
Operating principle .....	N/O or N/C operation individually selectable for each input
Factory setting .....	N/O operation
Voltage range (high) .....	AC/DC 10 ... 30 V
Voltage range (low) .....	AC/DC 0 ... 2 V
Power consumption .....	$\leq 2$ VA
Cable length per connection .....	$\leq 500$ m
Wire cross section at least $0.75 \text{ mm}^2$	

**Outputs**

Number/type .....	8/open collector
Voltage/power .....	max. DC 24 V/15 W
Cable length per connection .....	$\leq 10$ m
Wire cross section .....	at least $0.75 \text{ mm}^2$

### 10.6 I/O module BMI8/4 and BMI0/4

The I/O module BMI8/4 features 8 digital inputs and 4 relay outputs. The potential-free output relays utilise one changeover contact each AC 250 V, 5 A (AC1).

Der I/O module BMI10/4 features 4 relay outputs for the extension of the BMI8/4 module. The BMI10/4 module can only be used in conjunction with BMI8/4. The potential-free output relays utilise one changeover contact each AC 250 V, 5 A (AC1).

#### 10.6.1 BMI8/4 and BMI0/4 dimensions

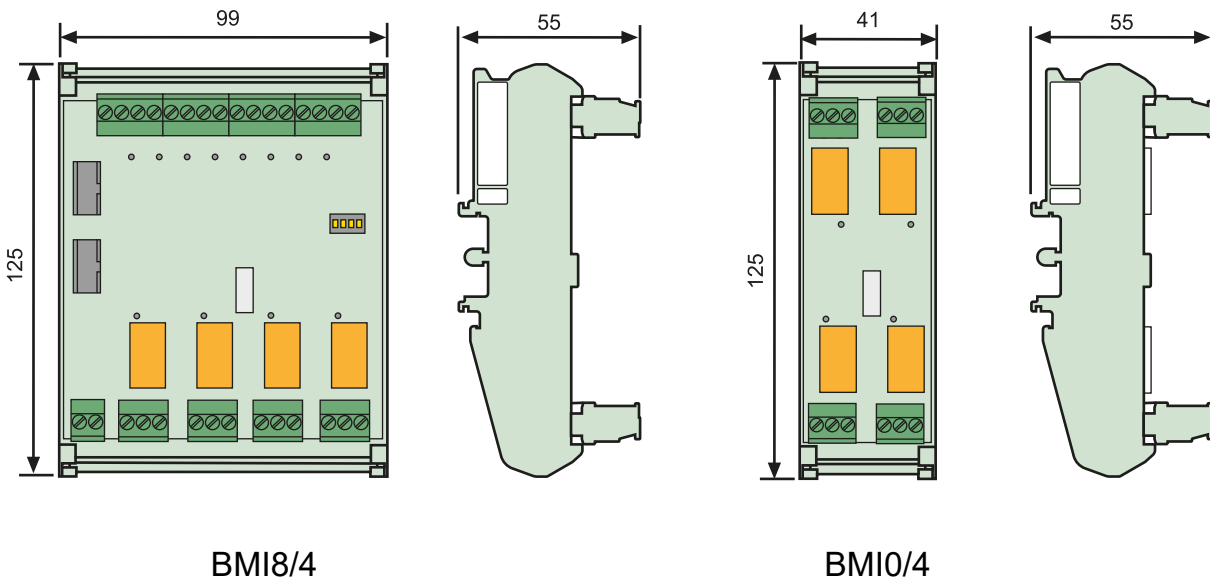

BMI8/4

BMI0/4

#### 10.6.2 Wiring diagram BMI8/4 and BMI0/4

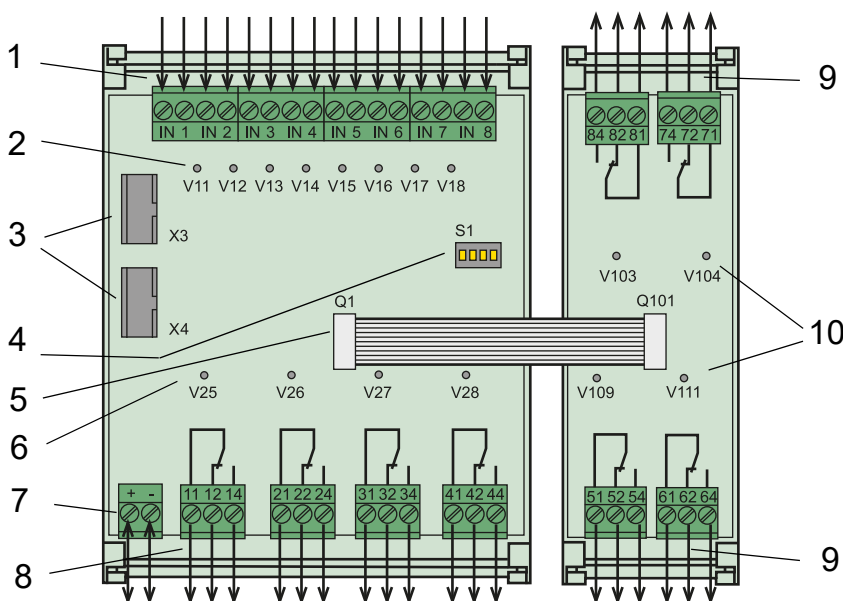



**Legend to wiring diagram BMI8/4 and BMI0/4**

1	IN1...8	Digital inputs 1...8 The digital inputs are be controlled either via potential-free contacts or via voltage signals.																				
2	V11...V18	Alarm LEDs, light up when voltage is present at the associated digital input. <table border="0" style="margin-left: 20px;"> <tr> <td>Input</td> <td>Alarm LED</td> <td>Input</td> <td>Alarm LED</td> </tr> <tr> <td>IN1</td> <td>V11</td> <td>IN5</td> <td>V15</td> </tr> <tr> <td>IN2</td> <td>V12</td> <td>IN6</td> <td>V16</td> </tr> <tr> <td>IN3</td> <td>V13</td> <td>IN7</td> <td>V17</td> </tr> <tr> <td>IN4</td> <td>V14</td> <td>IN8</td> <td>V18</td> </tr> </table>	Input	Alarm LED	Input	Alarm LED	IN1	V11	IN5	V15	IN2	V12	IN6	V16	IN3	V13	IN7	V17	IN4	V14	IN8	V18
Input	Alarm LED	Input	Alarm LED																			
IN1	V11	IN5	V15																			
IN2	V12	IN6	V16																			
IN3	V13	IN7	V17																			
IN4	V14	IN8	V18																			
3	X3, X4	Connector I <sup>2</sup> C bus for connecting additional I/O modules and connection to the display module.																				
4 S1		DIP switch for setting the address on the I <sup>2</sup> C bus by means of the bridge SJ (address 0 ... 15 = SJ open, address 16 ... 23 = SJ closed).																				
5	Q1, Q101	Connecting cable between BMI8/4 and BMI0/4																				
6	V25...V28	Alarm LEDs on the I/O module BMI8/4 light up when the associated relay is energised. <table border="0" style="margin-left: 20px;"> <tr> <td>Output</td> <td>Alarm LED</td> </tr> <tr> <td>11, 12, 14</td> <td>V25</td> </tr> <tr> <td>21, 22, 24</td> <td>V26</td> </tr> <tr> <td>31, 32, 34</td> <td>V27</td> </tr> <tr> <td>41, 42, 44</td> <td>V28</td> </tr> </table>	Output	Alarm LED	11, 12, 14	V25	21, 22, 24	V26	31, 32, 34	V27	41, 42, 44	V28										
Output	Alarm LED																					
11, 12, 14	V25																					
21, 22, 24	V26																					
31, 32, 34	V27																					
41, 42, 44	V28																					
7	A1, A2	Supply voltage $U_S$ DC																				
8	11, 12, 14...	4 relay outputs on the I/O module BMI8/4 41, 42, 44 for the activation of loads																				
9	51, 52, 54...	4 relay outputs on the I/O module BMI0/4 81, 82, 84 for the activation of loads																				
10	V103, V104	Alarm LEDs on the I/O module BMI0/4 light up V109, V111 when the associated relay is energised. <table border="0" style="margin-left: 20px;"> <tr> <td>Output</td> <td>Alarm LED</td> </tr> <tr> <td>51, 52, 54</td> <td>V109</td> </tr> <tr> <td>61, 62, 64</td> <td>V111</td> </tr> <tr> <td>71, 72, 74</td> <td>V104</td> </tr> <tr> <td>81, 82, 84</td> <td>V103</td> </tr> </table>	Output	Alarm LED	51, 52, 54	V109	61, 62, 64	V111	71, 72, 74	V104	81, 82, 84	V103										
Output	Alarm LED																					
51, 52, 54	V109																					
61, 62, 64	V111																					
71, 72, 74	V104																					
81, 82, 84	V103																					

**10.6.3 Technical data BMI8/4 and BMI0/4****Supply voltage BMI8/4**

Supply voltage $U_S$ .....	DC 24 V
Operating range $U_S$ .....	DC 18 ... 30 V

**Inputs BMI8/4**

Digital inputs	
Galvanic separation .....	yes
Activation of the digital inputs .....	via potential-free contacts/extraneous voltage
Operating principle .....	N/O or N/C operation individually selectable for each input
Factory setting .....	N/O operation
Voltage range (high) .....	AC/DC 10 ... 30 V
Voltage range (low) .....	AC/DC 0 ... 2 V
Power consumption .....	≤ 2 VA

**Outputs BMI8/4 a**

Switching elements .....	4 changeover contacts (AC 250 V, 5 A (AC1))
Operating principle .....	N/C operation or N/O operation programmable
Electrical service life under rated operating conditions .....	10,000 switching operations
Contact data acc. to IEC 60947-5-1	
Utilisation category .....	AC-13 ..... AC-14 ..... DC-12 ..... DC-12 ..... DC-12
Rated operational voltage.....	230 V 230 V 24 V 110 V 220 V
Rated operational current .....	5 A ..... 3 A ..... 1 A ..... 0.2 A ..... 0.1 A
Minimum contact rating.....	1 mA at AC/DC > 10 V

**Connections inputs/outputs**

Cable length per connection.....	≤ 500 m
Wire cross section at least .....	0.75 mm <sup>2</sup>

# INDEX

## A

Acknowledgement 57, 63  
Additional text 50, 52  
Alarm addresses 14, 59  
Alarm message 13  
    - neutral 62  
    - specific 62  
assigned devices 50  
Assignments 70  
Automatic mode 68

## B

Baud rate 65  
Beep code 45  
Bender service personnel 66  
bezel frame 19  
BMS bus  
    - external 15, 31  
    - internal 14, 31  
BMS-bus address 65  
BMS-bus addresses 31  
Buzzer  
    - Audio frequency 63  
    - Reminder 61  
Buzzer sound 62

## C

Cleaning agents 20  
Commissioning 37  
Commissioning pattern 37  
Common acknowledgement 63  
Connection 28  
Control 67  
Converter  
    - RS-232/RS-485 15

## D

Date 63  
Date format 63  
Delivery notes 20  
Design  
    - modular 16  
Device address 65  
Diagram 56  
Digital inputs 61  
Dimensions 75

DIP switch 31  
Display 13  
Displaying information 68

## E

Enclosure variants 19  
Enter button 50  
Error 45  
Error list 46  
Evaluating devices 68  
External devices 68

## F

Fault  
    - condition 51  
Firmware version 15, 55, 70  
Front plate 20, 24  
Front plate components 27  
Functional test 43

## G

Gases  
    - medical 62

## H

Hinges 27  
History memory 57

## I

Individual alarm texts 60  
Inputs  
    - digital 62  
Installation  
    - partially recessed 20  
Installation documentation 37  
Intended use 9  
Interfaces 14, 65

## J

Joint 22

## L

Language 64

LEDs 13

## M

Main menu 55  
Maintenance 44  
Master 31  
Master password 66  
Measurement addresses 61  
Medical gases 61  
MEDICS® system 11  
Menu mode 55  
Message text display 58  
Mounting frame 19  
Mounting plate 20

## N

National languages 14  
Navigation 56  
Normal  
    - operating condition 50

## O

Ordering information 76

## P

Parameter setting 39  
Parameters 71  
Password 56, 66  
Periodic verification 44  
Personnel 9  
Plaster cover 21

## Q

Quick reference guide 49

## R

Relay mode 65  
Repeater DI-1PSM 31  
Reset 67  
Reset mode 68

## S

Scroll 50

- Separation
  - safe 17
- Service 44
- Service menu 66
- Setting possibilities 71
- Settings 39, 40, 41, 59
- Signal converter SMI472-12 31
- Single mode 68
- Software 14
- Software version
  - 15
- Special characters
  - language specific 64
- Standard display 55
- Starting procedure 55
- Starting the EDS system 67
- Status information 13
- Status line 51, 52
- Suction cup 27, 76
- Summertime 63, 64
- surface-mounting enclosure 20
- Switching on 38, 39
- System components 7, 31
- System number 60

## T

- Terminating resistor
  - 31
- Tes addresses 60
- Test 50, 52
  - Error code 52
  - Error code note 53
- Test communication 68
- Test procedure 67
- Tests 37
- Text display 13
- Time 63
  - entire system 64
- TMK-History 15, 57
- TMK-SET 39, 41, 59, 61, 62
- Transfer rate 65

## U

- USB interface 15

## W

- Wiring diagram 30









**Bender GmbH & Co. KG**

P.O. Box 1161 • 35301 Gruenberg • Germany  
Londorfer Straße 65 • 35305 Gruenberg • Germany  
Tel.: +49 6401 807-0 • Fax: +49 6401 807-259  
E-mail: [info@bender.de](mailto:info@bender.de) • [www.bender.de](http://www.bender.de)

Fotos: Bender Archiv.



**BENDER Group**