

# COMTRAXX<sup>®</sup> CP305 - Control Panel

Remote alarm indicator  
for medical locations and other areas

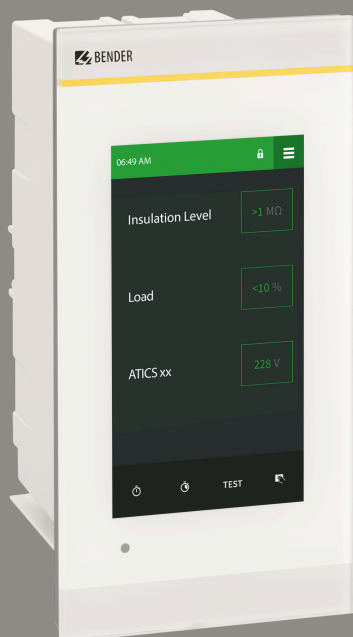

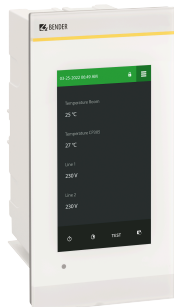

## Standards and approvals



The current overview of Bender devices with radio approval can be found in the Country list of RF Approval.

## Intended use

The COMTRAXX® CP305 control panel is for visual and acoustic signalling of operating and alarm messages from the Bender systems MEDICS®, ATICS®, EDS and RCMS. In MEDICS® monitoring systems, the CP305 fulfils the requirements of the standard DIN VDE 0100-710 concerning test functions for IT system monitoring and messaging from changeover devices. Testing of the IT system monitoring equipment is carried out via the test button and the devices to be tested.

### Important display functions

- Normal operation indicator
- Insulation fault
- Overload
- Overtemperature
- Interruption of the ISOMETER® mains or protective earth connection
- Supply line failure
- Power supply fault conditions and changeover device faults
- Device failure
- Test results
- Measured values

The connection between the CP305 and the transfer switching and monitoring modules is implemented with bus technology. During normal operation, the CP305 indicates the readiness for operation of the system.

The CP305 has 12 digital inputs with which messages from other systems can be received and displayed on the CP305, for example those dealing with medical gases or battery-supported central power supply systems (CBS equipment).

Two relay contacts make it possible to pass messages to the higher-order building management system. The relay contacts can also be used as switches that can be operated via the display.

CP305 devices are used in

- Healthcare facilities
- Industrial and office buildings
- Public buildings

Please heed the limits of the area of application indicated in the technical specifications. Operator control and adjustment of settings is partly done directly on the device or in a web browser.

Any other use than that described in this manual is regarded as improper.

Intended use includes:

- Equipment-specific settings compliant with local equipment and operating conditions
- Observation of all information in the operating manual
- Compliance with test intervals

## Applications

- Visualisation on the display optimally tailored to the user
- Integration of all compatible Bender products (MEDICS®, ATICS®, EDS, Linetraxx® RCMS systems and ISOMETER®)
- Individual instructions for action in the event of alarms

## Device features

### Properties

The CP305 display shows the messages from all RS-485 bus participants that have been allocated to it via alarm addresses. This means that a CP305 can be used not only as an individual display, but several CP305s can also be employed as parallel displays in different rooms.

The alarm colours for the LEDs are configurable (e.g. red for an alarm, yellow for a warning, such as an insulation fault or the like).

In addition to the LED, there is also an alarm pop-up (display) as well as an entry in the alarm overview (web user interface) when a message occurs. An acoustic signal sounds, for which the parameters can also be configured (can be acknowledged / muted).

If an additional message occurs while an existing message is pending, the acoustic signal sounds again and the messages are shown alternately on the display. Moreover, the address of the device that has triggered the alarm can be displayed. The acoustic signal is repeated after a configurable time (the repetition can also be switched off).

The menu system allows access to internal device parameters (alarm addresses, test addresses, etc.). Individual note texts can be configured for each alarm and test address. The CP305 can be employed as the master in systems consisting of several IT and EDS systems.

The "TEST" button can be used to check the function of the associated devices, such as insulation monitoring devices, LIM (Line Isolation Monitors) or GFCI (Ground Fault Circuit Interrupters). A message appears only on the CP305 on which the test was started. The test and its individual evaluations run sequentially. Afterwards, a message concerning the successful test or a fault message is output.

In bus networks (BMS) with more than one master-capable device, one CP305 used as a backup master is able to maintain the functionality of the bus communication.

CP305 devices have the following properties:

- Display of operating, warning, and alarm messages according to DIN VDE 0100-710, IEC 60364-7-710 and other standards
- 12 digital inputs
- 2 relay contacts (changeover contacts) that can also be operated using a switch on the display
- Plaintext display with backlit 5" touch display
- Easy to clean and disinfect, degree of protection IP54 (overall device) and IP66 (front glass panel)
- Front glass panel mounted without screws
- User-friendly, touch-sensitive monitoring system for medical uses and other applications
- Exceptionally simple user guidance
- Additional information for medical and technical personnel
- Visual and acoustic signalling in the event of an alarm
- Clear menu structure
- Silent due to fanless operation
- High-quality visualization with outstanding contrast, high resolution and a wide viewing angle
- Device testing and modification of the parameter settings with minimal service interruptions
- Standard texts for messages can be selected in the national language
- 2 languages can be configured and switching between them is possible during operation
- 500 freely programmable message texts
- Bus technology for simple installation and low fire load
- Acoustic alarm can be acknowledged / muted
- Versions for flush mounting and surface mounting
- Predefined message texts simplify start-up
- History memory with real time clock for storing 1000 warning and alarm messages
- Voltage supply via power supply unit
- Parameter configuration via Ethernet interface
- NFC interface for connecting to the Bender Connect App
- Replace MK2430 (retrofit); other devices on request

### System description

#### Certification

COMTRAXX® CP305 are UL certified.

#### MEDICS®

The CP305 remote alarm indicators are components of the MEDICS® systems. MEDICS® is an intelligent system that guarantees safe power supply in medical locations.

#### Connection example BMS

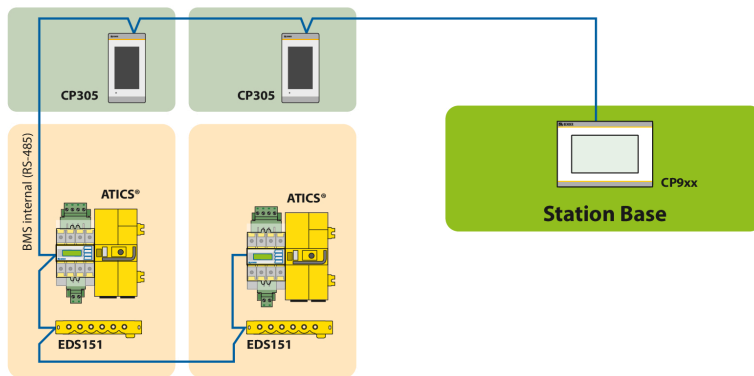

In the example, the ICU is monitored from the station base via BMS bus.

#### Connection example BMS and Ethernet

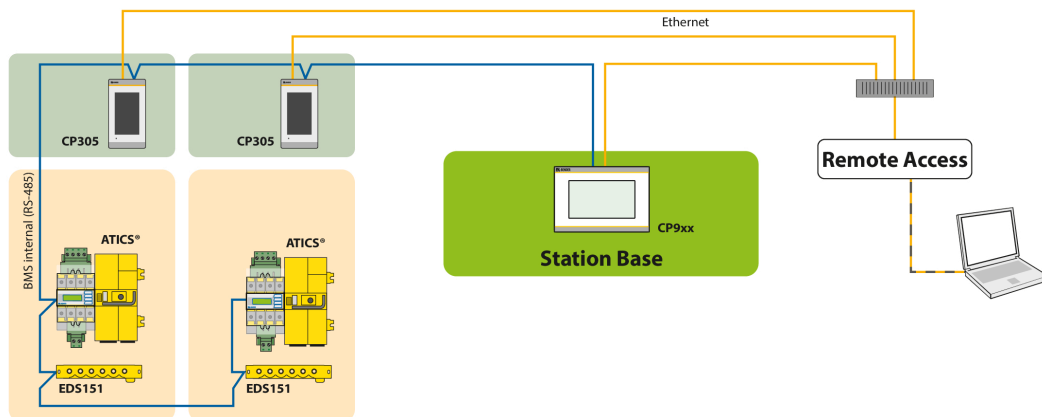

In the example, the ICU can be monitored from the station base. In addition, remote maintenance is possible via the building services or Bender.

**i** For safe operation of the Medics® system in accordance with IEC 60364-7-710 and IEC 61557-8, we recommend operating the self-monitoring system with a second master-capable device from the Control Panel family.

**Connection example for Modbus RTU and Ethernet**



In the example, remote maintenance via the building services or by Bender is possible.

**NFC (near-field communication)**

The powered device can also have its parameters set via NFC. The interface is activated on the CP305 under > Settings > Interface > NFC. Afterwards, the prepared configuration can be loaded onto the device using the Bender Connect app.

Electromagnetic disturbances may affect the NFC dialog between the CP305 and an external NFC transceiver.



The NFC interface can be used to transmit a previously configured device parameter setting directly to the device.

**i** This function is available only via the Bender Connect App. You can find this app in the Appstores for iOS and Android.



In the Bender Connect app the device first needs to be made known. Then the device-specific setting options are shown so that they can be configured. When the data is transferred, feedback is given whether the parameter configuration has been successful.

Parameter settings can be transmitted to the device via the Bender Connect app by holding the mobile phone close to the device.



To a **de-energised** device, a parameter setting can be transferred via the Bender Connect app. This setting is then activated automatically when the device is connected to the current supply.

When a device is **plugged in**, too, parameters can be configured via the Bender Connect App. To this end, the NFC interface first needs to be activated in the device.



Connection diagram

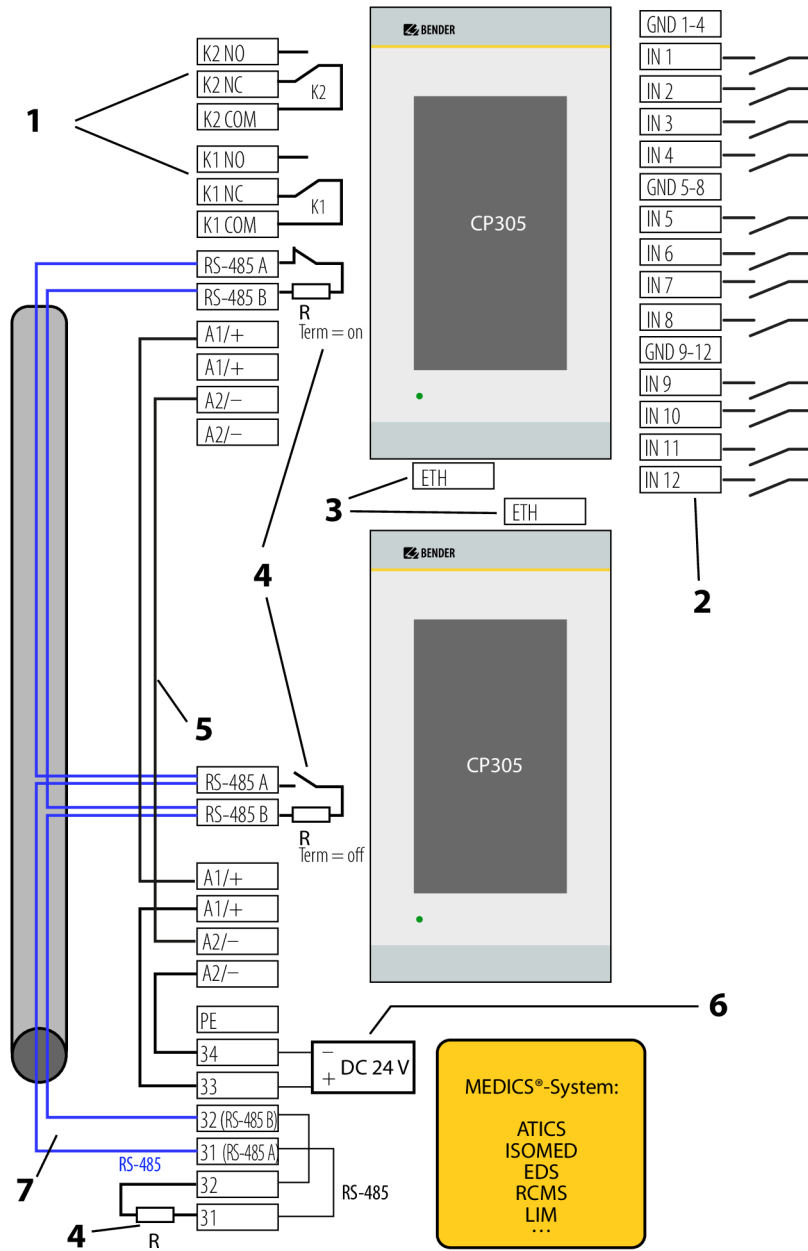

## Legend for the connection diagram

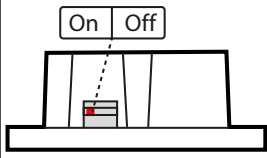
No.	Terminal	Explanation	
1	K...COM K...NC K...NO	<b>2 relay outputs</b> Parametrisable contacts for device errors, test of assigned devices**, device failure and common alarm message.	
2	IN1...12 GND...	<b>Digital inputs</b> The digital inputs are divided into three groups of four, which are galvanically separated from each other and from the device. Each group has its own GND terminal for the reference potential. If the inputs are controlled via an external voltage, the common reference potential is connected to the "GND" terminal and the signal is connected to the respective input IN1...12.	
3	ETH	<b>Ethernet interface</b> for connection of a PC The CP305 can be integrated into the Bender/hospital network via the Ethernet interface. Parameters can be set on the PC, and data as well as the history memory can be read out. Connected measuring devices can be displayed with their channels.	
4	R	<b>Terminating resistor of RS-485 interface</b> If two or more devices are connected to each other via RS-485, the bus line must be terminated at both ends with a resistor ( $R = 120 \Omega$ ) (can be switched on via dip switch on the underside of the CP305).	
5	A1+/A2- ~	<b>Supply voltage</b> Adhere to the permissible cable lengths and cross sections when supplying the CP305 in the MEDICS® modules.	
6	DC 24 V	<b>power supply unit</b> in the MEDICS® module, sufficient for supplying power to up to two CP305 devices.	
7	RS-485 A RS-485 B	<b>BMS bus connection</b> (see also D00276) oder <b>BSC-RTU bus connection</b> Cable: Shielded, one end of shield connected to PE Recommended CAT6/CAT7 min. AWG23 Alternatively Cable, twisted pairs, J-Y(St)Y min. 2x0.8 Connect shield to PE on one side Various Bender devices with a BMS bus interface. Examples: ATICS, ISOMED427P, EDS151, RCMS..., CP9xx, ... Various Bender devices with a BSC-RTU bus interface. Examples: LIM...	

\*\* Devices without BMS bus connection, but with test input (e.g ISOMETER)

## Technical Data

### Insulation coordination acc. to IEC 60664-1

Rated voltage	50 V
Overvoltage category	II
Pollution degree	2

Overvoltage category II and pollution degree 2 is related to the relay contacts. Further insulation coordination takes place after functional separation.

### Supply via plug-in terminal (A1/+, A2/-)

Rated voltage	AC/DC 24 V
Operating range of the supply voltage	AC 18...28 V/DC 18...30 V
Nominal frequency	50/60 Hz
Typical power consumption	< 4.2 W
Maximum cable length with supply via B95061210 (24 V DC power supply unit 1.75 A)	
0.28 mm <sup>2</sup>	75 m
0.5 mm <sup>2</sup>	130 m
0.75 mm <sup>2</sup>	200 m
1.5 mm <sup>2</sup>	400 m
2.5 mm <sup>2</sup>	650 m

### Stored energy time in the event of voltage failure

Time, date	Min. 2 days
Restart after power failure	Min. 2 seconds

### Displays, memory

Display	5" TFT touch display (720 x 1280 px)
Displayable devices	90
Number of alarm addresses	500
Number of test addresses	50
Number of history memory entries	1000

### Interfaces

#### Ethernet

Connection	RJ45
Data rate	10/100 Mbit/s, autodetect
DHCP	on/off (on)*
IP address (1:1 connection)	169.254.xx.yy (xx and yy are unique for each device)
Netmask	nnn.nnn.nnn.nnn (255.255.255.0)*
Logs	TCP/IP, Modbus TCP, DHCP, SNTP

#### Ethernet

Protocol	<b>Modbus TCP</b>
(for reading the digital inputs and relay outputs only)	
Operating mode	Slave

#### RS-485

Protocol	<b>BMS internal</b>
Operating mode	Master/slave (master)*
Baud rate	9.6 kBit/s
Cable length	< 1200 m
Shielded cable, one end of shield connected to PE	Recommended: CAT6/CAT7 min. AWG23 Alternative: J-Y(St)Y min. 2 x 0.8
Galvanic separation	Yes
Connection	"RS-485 A", "RS-485 B" (see plug-in terminal)
Terminating resistor	120 Ω (0.25 W), can be connected internally
Device address	1...90 (1)*
Number of supported devices	89

#### RS-485

Protocol	<b>Modbus RTU</b>
Operating mode	Master
Baud rate	19.2 kBaud
Parity	even, odd, none (even)*
Stop bits	1, 2, auto (1)*
Alarm query interval	0...30 s (2 s)*
Cable length	< 1200 m
Shielded cable, one end of shield connected to PE	Recommended: CAT6/CAT7 min. AWG23 Alternative: J-Y(St)Y min. 2 x 0.8
Galvanic separation	Yes
Connection	"RS-485 A", "RS-485 B" (see plug-in terminal)
Terminating resistor	120 Ω (0.25 W), can be connected internally
Device address	1
Number of supported devices	30

### Digital inputs (1...12)

Number	12
Galvanic separation	In groups of four IN 1...4 / GND 1-4 IN 5...8 / GND 5-8 IN 9...12 / GND 9-12
Operating mode	Can be selected for each input: high-active or low-active
Factory setting	Off
Voltage range (high)	AC/DC 10...30 V Nominal: 24 V
Voltage range (low)	AC/DC 0...2 V
Max. current per channel (at AC/DC 30 V)	8 mA
Connection	Plug-in terminals IN 1... 4 / GND1-4 IN 5...8 / GND 5-8 IN 9...12 / GND 9-12
Maximum cable length	< 500 m



## Switching elements

Connection	Plug-in terminal K1 NC; K1 NO; K1 COM K2 NC; K2 NO; K2 COM
Number of changeover contacts	2
Operating principle (changeover contacts)	N/C operation / N/O operation
Function	Programmable
Minimum contact load	100 mA/DC 5 V (0.5 W)
Electrical endurance under rated operating conditions	10,000 operating cycles

### Contact data acc. to IEC 60947-5-1

Utilisation category	AC-13 AC-14 DC-12
Rated operational voltage	AC 24 V AC 24 V DC 24 V
Rated operational current	AC 2 A AC 2 A AC 2 A

## Buzzer

Buzzer alarm	Can be acknowledged, adoption of characteristics of new value, can be muted
Buzzer interval	Configurable
Buzzer frequency	Configurable
Buzzer repetition	Configurable

## Device connections

### Plug-in terminal (A1/+, A2/-)

Conductor sizes	AWG 24...12
Stripping length	10 mm
Rigid/flexible	0.2...2.5 mm <sup>2</sup>
Flexible with ferrules, with/without plastic sleeve	0.25...2.5 mm <sup>2</sup>
Multiple conductor flexible with TWIN ferrule with plastic sleeve	0.5...1.5 mm <sup>2</sup>

### Plug-in terminals

(RS-485 A, RS-485 B), (IN1...4, GND1...4, IN9...12, GND9...12) (IN5...8, GND5...8, K1..., K2...)

Conductor sizes	AWG 24...16
Stripping length	10 mm
Rigid/flexible	0.2...1.5 mm <sup>2</sup>
Flexible with ferrule without plastic sleeve	0.2...1.5 mm <sup>2</sup>
Flexible with ferrule with plastic sleeve	0.2...1.5 mm <sup>2</sup>

### For UL applications

Use copper lines only.

Minimum temperature range of the cable to be connected to the plug-in terminals	75 °C
---	-------

## Environment/EMC

EMC	IEC 61000-6-2:2016-08 Ed. 3.0 IEC 61000-6-3:2020-07 Ed. 3.0 IEC 61326-1:2020-10 Ed. 3.0 DIN EN 61326-1:2013-07 DIN EN 50364:2019-05 EN 300 330 V2.1.1 ETSI EN 301 489-3 V2.3.0
Operating temperature	-10...+55 °C
Operating temperature for UL applications	-10...+50 °C
Operating altitude	≤ 2000 m AMSL
Rel. humidity	≤ 98 % at 25 °C

### Classification of climatic conditions acc. to IEC 60721

Stationary use (IEC 60721-3-3)	3K22
Transport (IEC 60721-3-2)	2K11
Long-term storage (IEC 60721-3-1)	1K22

### Classification of mechanical conditions acc. to IEC 60721

Stationary use (IEC 60721-3-3)	3M11
Transport (IEC 60721-3-2)	2M4
Long-term storage (IEC 60721-3-1)	1M12

## Other

Operating mode	Continuous operation
Mounting position	Display-oriented, adjustable horizontal/vertical display orientation
Degree of protection of front glass pane	IP66
Degree of protection of front for UL applications	IP50
Degree of protection of enclosure	IP20
Degree of protection mounted flush with wall	IP54
Flammability class	UL 94V-0
Device dimensions (W x D x H)	181 x 96 x 37.1 mm
Weight	< 420 g

()\* = Factory setting

**Dimension diagram CP305**

All dimensions are in mm.

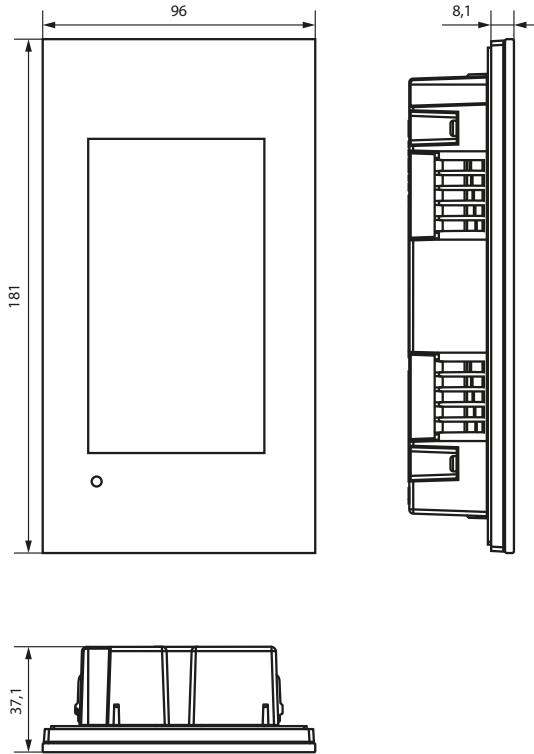

**Surface mounting**

Surface mounting requires use of the appropriate surface-mounting enclosure (part. no. B95100153).

All dimensions are in mm.

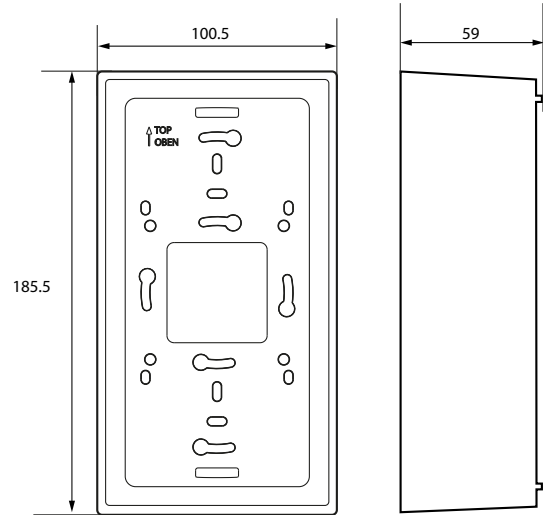

**i** Any clearance between the surface-mounting enclosure and the wall must be compensated using washers. Never tighten the screws with a cordless screwdriver; only do so by hand. If this is disregarded, the surface-mounted housing can become warped.

**Dimension diagram flush-mounting enclosure**

All dimensions are in mm.

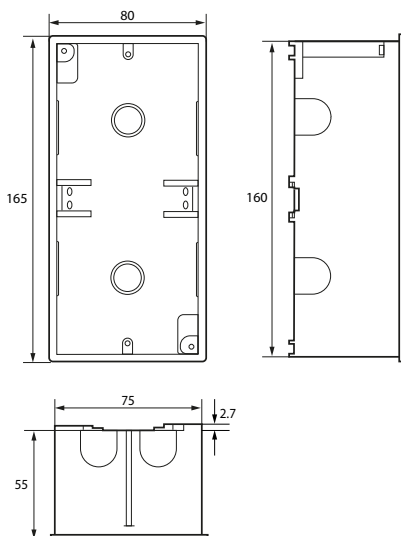

**Cavity wall and panel mounting**

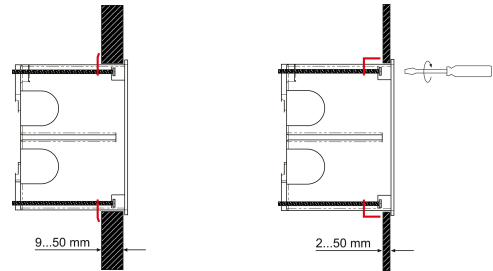

**Cavity wall mounting**

**Panel mounting**

Mounting kit required

B923711

B95101000

**Ordering information**
**Device variants**

Type	Description	Art. No.
CP305-IO		B95100051
CP305-C	Customised parameter settings	B22030051

**Accessories**

Type	Description	Art. No.
Flush-mounting enclosure		B923710
Cavity wall installation set for flush-mounting enclosure B923710	Installation kit for flush-mounting enclosure	B923711
DIN rail mounting and control panel installation set for flush-mounting enclosure B923710	Installation kit for CPx05	B95101000
CP305 surface-mounting enclosure		B95100153
CP305-IO plug kit	CP305-IO connector kit	B95100151
Ethernet adapter kit (RJ45 socket insert, Cat.6 SLIM patch cable)	Ethernet connector kit	B95100152



**Bender GmbH & Co. KG**

Londorfer Straße 65  
35305 Grünberg  
Germany

Tel.: +49 6401 807-0  
info@bender.de  
www.bender.de



© Bender GmbH & Co. KG, Germany  
Subject to change!  
The specified standards take into account the  
edition valid until 02.2025 unless otherwise  
indicated.